

Technics®

AV Control Stereo Receiver

Operating Instructions

Model No. **SA-DA10**
SA-DA8



The photographs show the gold version of SA-DA8.
Model SA-DA10 is only for the United Kingdom.
The black version of SA-DA8 is only for the United Kingdom.



Note:
“EB” on the packaging indicates the United Kingdom.

Before connecting, operating or adjusting this product,
please read these instructions completely.
Please keep this manual for future reference.

EB GN

RQT5518-B

Dear customer

Thank you for purchasing this product.
For optimum performance and safety, please read these instructions carefully.

Table of contents

Caution for AC Mains Lead	3
Safety precautions	4
To enjoy surround sound	5
Front panel controls	6
Concerning the remote control	9
<hr/>	
Connections	10
Connecting a DVD player	10
Connecting video equipment	11
Connecting audio equipment	12
Antenna connections	12
Connecting the AC mains lead and other information	13
Speaker connections	14
Placement of speakers	14
Connecting speakers	15
<hr/>	
Preparatory steps	17
Speaker settings	17
Adjusting speaker output level	19
<hr/>	
DSP sound modes	20
Enjoying the sounds	22
To enjoy bi-amp sound	24
To adjust the tone quality	25
To adjust the sound balance	25
When using the VCR 3 terminals	25
Switching DVD analogue input	26
VGCA mode	27
<hr/>	
The radio	28
Sequential tuning	28
Direct tuning	29
Preset tuning	30
RDS broadcasts Only for the United Kingdom	32
To display RDS information	32
PTY search and EON tuning	33
About the PTY display	35
<hr/>	
Other functions	36
To listen through headphones	36
Dynamic range compression	36
To mute the sound level	37
When using the unit in a darkened room	37
<hr/>	
The remote control	38
To operate the receiver	39
To operate a CD player or MD deck	41
To operate a cassette deck	41
To watch TV broadcasts	43
To watch video tapes	43
To operate a DVD player	45
To change the remote control code	46
<hr/>	
Making a recording	48
Recording on a tape deck or VCR	48
Timer function	49
Setting the timers	49
Troubleshooting guide	50
The RESET function	51
Maintenance	51
Specifications	Back cover

These operating instructions are applicable to models for the United Kingdom, Australia and New Zealand, however, are intended primarily for the United Kingdom model.

Supplied accessories

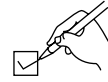

Please check and identify the supplied accessories.

- AC mains lead 1 pc.

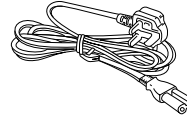

For the United Kingdom
(VJA0733)

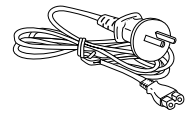

For Australia and New Zealand
(RJA0035-X)

- AM loop antenna set 1 pc.
- AM loop antenna 1 pc.
 - AM loop antenna holder 1 pc.
 - Screw 1 pc.

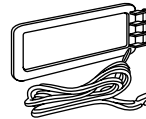

(RSA0012)

- FM indoor antenna 1 pc.



(RSA0007)

- Antenna plug 1 pc.

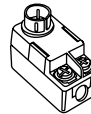

Only for Australia and New Zealand
(RFE0014)

- Antenna plug 1 pc.



Only for the United Kingdom
(SJP9009)

- Batteries 2 pcs.

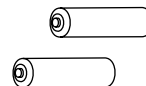

- Remote control 1 pc.

SA-DA10

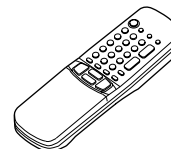

Only for the United Kingdom
(Gold model EUR51986)
(Black model EUR51987)

SA-DA8



For the United Kingdom
(EUR647136)



For Australia and New Zealand
(EUR647137)

Use numbers indicated in parentheses when asking for replacement parts.

Caution for AC Mains Lead

(For United Kingdom)

("EB" area code model only)

For your safety, please read the following text carefully.

This appliance is supplied with a moulded three pin mains plug for your safety and convenience.

A 5-ampere fuse is fitted in this plug.

Should the fuse need to be replaced please ensure that the replacement fuse has a rating of 5-ampere and that it is approved by ASTA or BSI to BS1362.

Check for the ASTA mark  or the BSI mark  on the body of the fuse.

If the plug contains a removable fuse cover you must ensure that it is refitted when the fuse is replaced.

If you lose the fuse cover the plug must not be used until a replacement cover is obtained.

A replacement fuse cover can be purchased from your local dealer.

CAUTION!

IF THE FITTED MOULDED PLUG IS UNSUITABLE FOR THE SOCKET OUTLET IN YOUR HOME THEN THE FUSE SHOULD BE REMOVED AND THE PLUG CUT OFF AND DISPOSED OF SAFELY.

THERE IS A DANGER OF SEVERE ELECTRICAL SHOCK IF THE CUT OFF PLUG IS INSERTED INTO ANY 13-AMPERE SOCKET.

If a new plug is to be fitted please observe the wiring code as stated below.

If in any doubt please consult a qualified electrician.

IMPORTANT

The wires in this mains lead are coloured in accordance with the following code:

Blue: Neutral, Brown: Live.

As these colours may not correspond with the coloured markings identifying the terminals in your plug, proceed as follows:

The wire which is coloured Blue must be connected to the terminal which is marked with the letter N or coloured Black or Blue.

The wire which is coloured Brown must be connected to the terminal which is marked with the letter L or coloured Brown or Red.

WARNING: DO NOT CONNECT EITHER WIRE TO THE EARTH TERMINAL WHICH IS MARKED WITH THE LETTER E, BY THE EARTH SYMBOL \perp OR COLOURED GREEN OR GREEN/YELLOW.

THIS PLUG IS NOT WATERPROOF—KEEP DRY.

Before use

Remove the connector cover.

How to replace the fuse

The location of the fuse differ according to the type of AC mains plug (figures A and B). Confirm the AC mains plug fitted and follow the instructions below. Illustrations may differ from actual AC mains plug.

1. Open the fuse cover with a screwdriver.

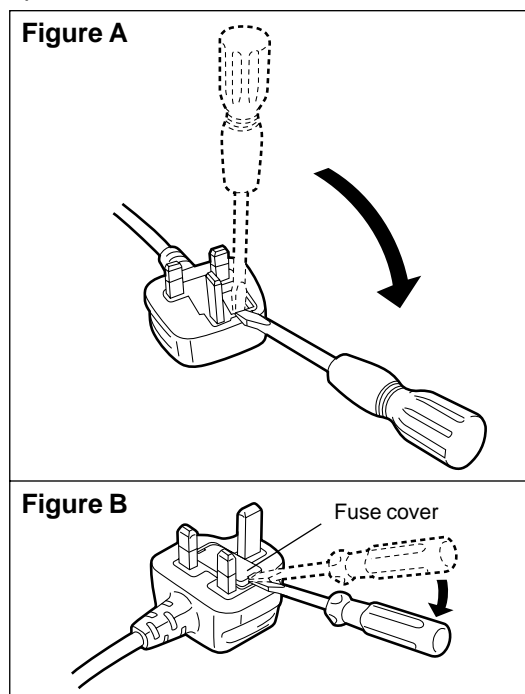

2. Replace the fuse and close or attach the fuse cover.

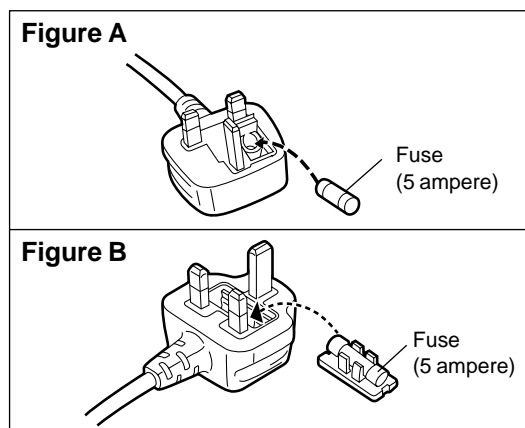

Safety precautions

Placement

Set the unit up on an even surface away from direct sunlight, high temperatures, high humidity, and excessive vibration. These conditions can damage the cabinet and other components, thereby shortening the unit's service life.

Place it at least 15 cm away from wall surfaces to avoid distortion and unwanted acoustical effects.

Do not place heavy items on the unit.

Voltage

Do not use high voltage power sources. This can overload the unit and cause a fire.

Do not use a DC power source. Check the source carefully when setting the unit up on a ship or other place where DC is used.

AC mains lead protection

Ensure the AC mains lead is connected correctly and not damaged. Poor connection and lead damage can cause fire or electric shock. Do not pull, bend, or place heavy items on the lead. Grasp the plug firmly when unplugging the lead. Pulling the AC mains lead can cause electric shock.

Do not handle the plug with wet hands. This can cause electric shock.

Foreign matter

Do not let metal objects fall inside the unit. This can cause electric shock or malfunction.

Do not let liquids get into the unit. This can cause electric shock or malfunction. If this occurs, immediately disconnect the unit from the power supply and contact your dealer.

Do not spray insecticides onto or into the unit. They contain flammable gases which can ignite if sprayed into the unit.

Service

Do not attempt to repair this unit by yourself. If sound is interrupted, indicators fail to light, smoke appears, or any other problem that is not covered in these instructions occurs, disconnect the AC mains lead and contact your dealer or an authorized service center. Electric shock or damage to the unit can occur if the unit is repaired, disassembled or reconstructed by unqualified persons.

Extend operating life by disconnecting the unit from the power source if it is not to be used for a long time.

CAUTION!

DO NOT INSTALL OR PLACE THIS UNIT IN A BOOKCASE, BUILT IN CABINET OR IN ANOTHER CONFINED SPACE. ENSURE THE UNIT IS WELL VENTILATED. ENSURE THAT CURTAINS AND ANY OTHER MATERIALS DO NOT OBSTRUCT THE VENTILATION TO PREVENT RISK OF ELECTRIC SHOCK OR FIRE HAZARD DUE TO OVERHEATING.

CAUTION

Do not place anything on top of this unit or block the heat radiation vents in any way. In particular, do not place tape decks or CD/DVD players on this unit as heat radiated from it can damage your software.

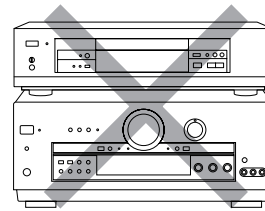

NO

To enjoy surround sound

Do the connections, settings, and adjustments in the order shown to enjoy surround sound. Be sure to make the correct speaker settings. If, for example, you have not connected a center speaker and you leave the initial setting value of LARGE as it is, then dialog and other sounds may not be reproduced.

Connect the equipment

(→ Pages 10–13.)



Position and connect the speakers

(→ Pages 14–16.)

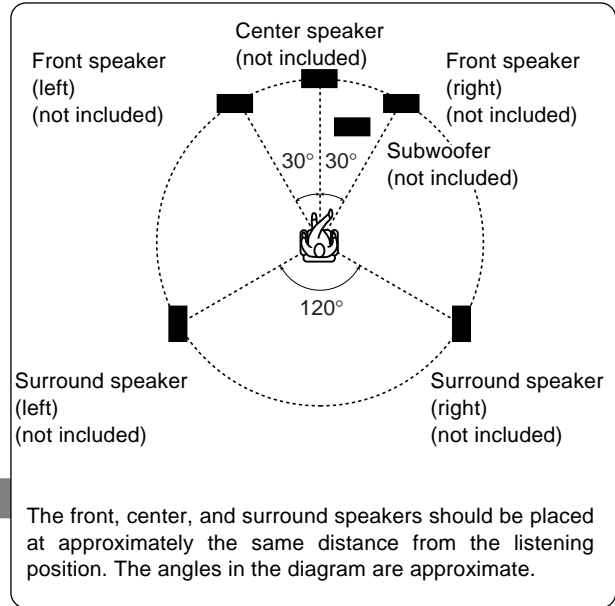

Set the presence and type (small/large), distance and filter of the speakers you have connected

(→ Pages 17–18.)

In SIZE

Select LARGE or SMALL for the front speakers
Select LARGE, SMALL, or NONE for the center and surround speakers
Select YES or NO for the subwoofer

In DISTANCE

Enter the distance of the front, center, and surround speakers from the listening position

In FILTER

Enter the cutoff frequency for your subwoofer based on the bass capability of your front speakers



Adjust the level for the speakers

(→ Page 19.)

While sitting in the usual listening position, use the test signal to adjust the volume of the speakers to the same apparent level.



Sit back and enjoy the experience

(→ Pages 22–23.)

When using DVD 6CH INPUT mode

These settings need to be changed on the player. Read the player's instructions for setting details.

Front panel controls

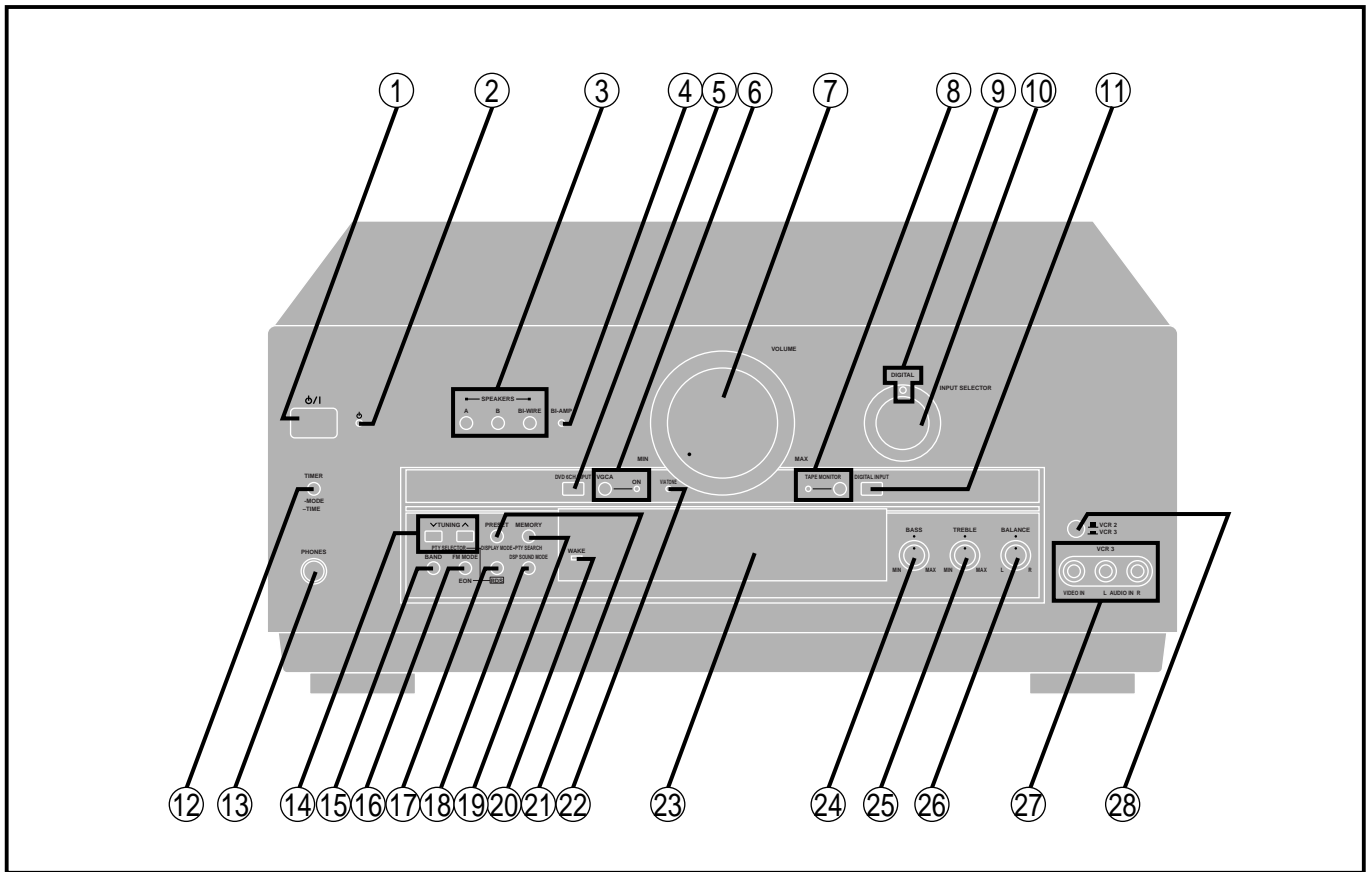

Main unit

No.	Name	Ref. page	No.	Name	Ref. page
①	Standby/on switch (⏻/⏻)	17	⑮	Band select button (BAND)	28
	Press to switch the unit from on to standby mode or vice versa.		⑯	For the United Kingdom	
	In standby mode, the unit is still consuming a small amount of power.			FM mode select/EON button (FM MODE, EON)	28, 34
②	Standby indicator (⏻)			For Australia and New Zealand	
	When the unit is connected to the AC mains supply, this indicator lights up in standby mode and goes out when the unit is turned on.			FM mode select button (FM MODE)	28
③	Speaker select buttons (SPEAKERS, A, B, BI-WIRE)	17, 22	⑰	Only for the United Kingdom	
④	Bi-amp indicator (BI-AMP)	24		RDS button (RDS)	32
⑤	DVD 6CH input select button (DVD 6CH INPUT)	26	⑱	For the United Kingdom	
⑥	VGCA mode select button/indicator (VGCA, ON)	27		Memory/PTY search button (MEMORY, PTY SEARCH)	30, 33
⑦	Volume control (VOLUME)	23		For Australia and New Zealand	
⑧	Tape monitor button/indicator (TAPE MONITOR)	24		Memory button (MEMORY)	30
⑨	Digital input indicator (DIGITAL)	22	⑳	Wake indicator (WAKE)	49
⑩	Input selector (INPUT SELECTOR)	17, 22	㉑	For the United Kingdom	
⑪	Digital input select button (DIGITAL INPUT)	22		Preset channel/Display mode select button (PRESET, DISPLAY MODE)	31, 32
⑫	Timer button (TIMER, -MODE, -TIME)	49		For Australia and New Zealand	
⑬	Headphones jack (PHONES)	36		Preset channel button (PRESET)	31
⑭	For the United Kingdom		㉒	Via tone indicator (VIA TONE)	27
	Tuning/PTY select buttons (TUNING, ∇, ∆, PTY SELECTOR)	28, 33	㉓	Display section	7
	For Australia and New Zealand		㉔	Bass control (BASS)	25
	Tuning buttons (TUNING, ∇, ∆)	28	㉕	Treble control (TREBLE)	25
			㉖	Balance control (BALANCE)	25
			㉗	VCR 3 terminals (VCR 3)	11
			㉘	VCR 2/VCR 3 select button (VCR 2, VCR 3)	25

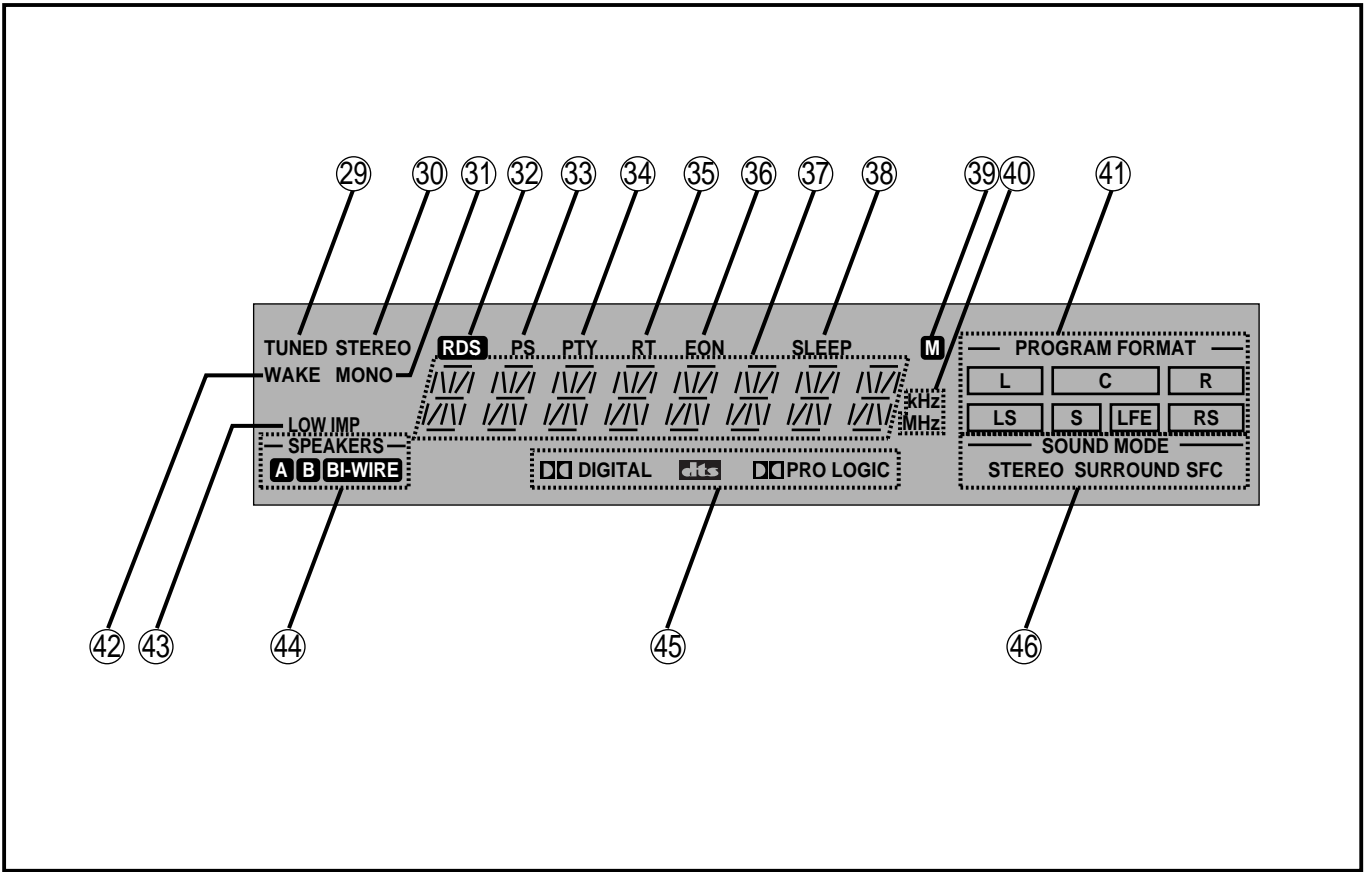

Display section

No.	Name	Ref. page
29	Tuned indicator (TUNED)	28
30	Stereo indicator (STEREO)	28
31	Monaural indicator (MONO)	28
32	Only for the United Kingdom RDS indicator (RDS)	32
33	Only for the United Kingdom PS indicator (PS)	32
34	Only for the United Kingdom PTY indicator (PTY)	32
35	Only for the United Kingdom RT indicator (RT)	32
36	Only for the United Kingdom EON indicator (EON)	34
37	Display	
38	Sleep indicator (SLEEP)	49

No.	Name	Ref. page
39	Memory indicator (M)	30
40	Frequency unit indicator (kHz, MHz)	28
41	Program format indicators (PROGRAM FORMAT, L, C, R, LS, S, LFE, RS)	20
42	Wake indicator (WAKE)	49
43	Low impedance indicator (LOW IMP)	24
44	Front speaker indicator (-SPEAKERS-, A, B, BI-WIRE)	22
45	Signal format indicators (DIGITAL, DTS, PRO LOGIC)	20
46	DSP sound mode indicators (SOUND MODE, STEREO, SURROUND, SFC)	20

Front panel controls

Remote control

SA-DA10

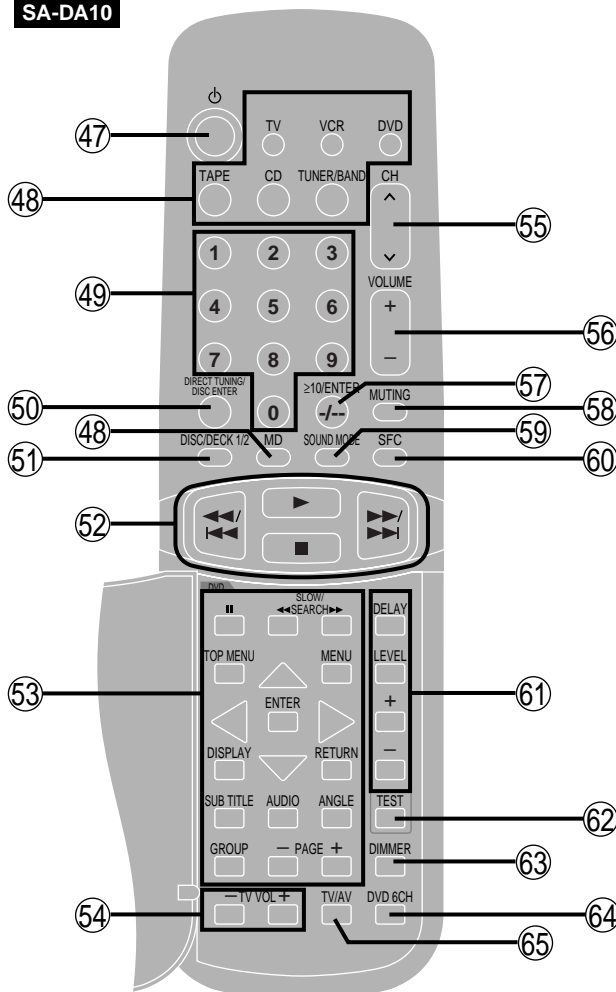

SA-DA8

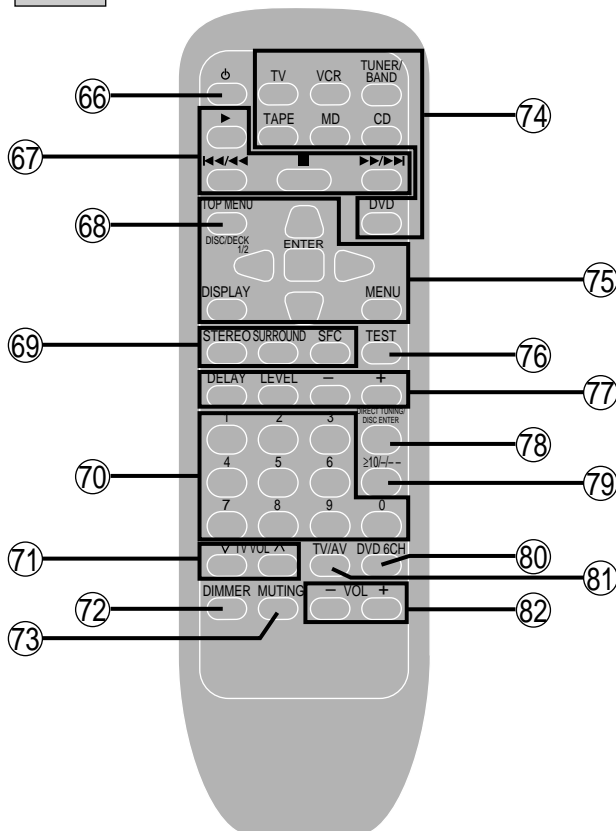

No.	Name	Ref. page
SA-DA10		
47	Standby/on button (⏻)	39
48	Input select buttons (TV, VCR, DVD, TAPE, CD, TUNER/BAND, MD)	39
49	Numbered buttons	29, 39
50	Direct tuning/disc enter button (DIRECT TUNING/DISC ENTER)	29, 39
51	Disc/deck 1/2 select button (DISC/DECK 1/2)	41
52	Disc and deck operation buttons (◀◀/◀, ▶, ▶▶/▶▶)	41
53	DVD player operation buttons	45
54	TV volume buttons (-TV VOL+)	43
55	Channel up/down button (CH, ∇, ▲)	39
56	Volume buttons (VOLUME, +, -)	19, 39
57	≥10/ENTER, -/- button (≥10/ENTER, -/-)	39
58	Muting button (MUTING)	37, 39
59	DSP sound mode select button (SOUND MODE)	39
60	SFC mode select button (SFC)	23, 39
61	Delay time/level adjust buttons (DELAY, LEVEL, +, -)	19, 23, 39
62	Test button (TEST)	19, 39
63	Dimmer button (DIMMER)	37, 39
64	DVD 6CH input select button (DVD 6CH)	39
65	TV/AV select button (TV/AV)	43
SA-DA8		
66	Standby/on button (⏻)	39
67	Disc and deck operation buttons (▶, ◀◀/◀◀, ■, ▶▶/▶▶)	41
68	Disc/deck 1/2 select button (DISC/DECK 1/2)	41
69	DSP sound mode and SFC mode select buttons (STEREO, SURROUND, SFC)	23, 39
70	Numbered buttons	29, 39
71	TV volume buttons (∇ TV VOL ▲)	43
72	Dimmer button (DIMMER)	37, 39
73	Muting button (MUTING)	37, 39
74	Input select buttons	
For the United Kingdom		
	(TV, VCR, TUNER/BAND, TAPE, MD, CD, DVD)	39
For Australia and New Zealand		
	(TV, VCR, TUNER/BAND, TAPE, CD, DVD)	39
75	DVD player operation buttons	45
76	Test button (TEST)	19, 39
77	Delay time/level adjust buttons (DELAY, LEVEL, -, +)	19, 23, 39
78	Direct tuning/disc enter button (DIRECT TUNING/DISC ENTER)	29, 39
79	≥10/-/- button (≥10/-/-)	39
80	DVD 6CH input select button (DVD 6CH)	39
81	TV/AV select button (TV/AV)	43
82	Volume buttons (- VOL +)	19, 39

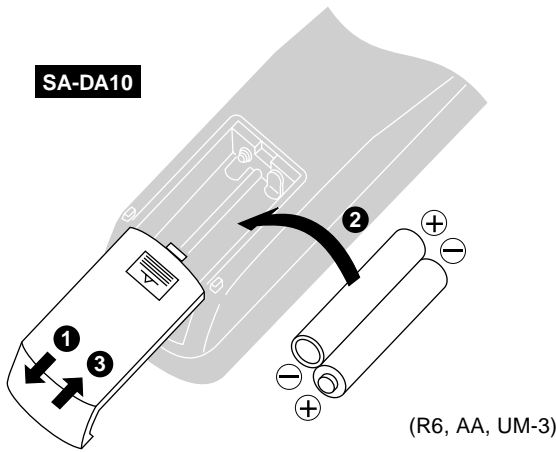
A**SA-DA10**

(R6, AA, UM-3)

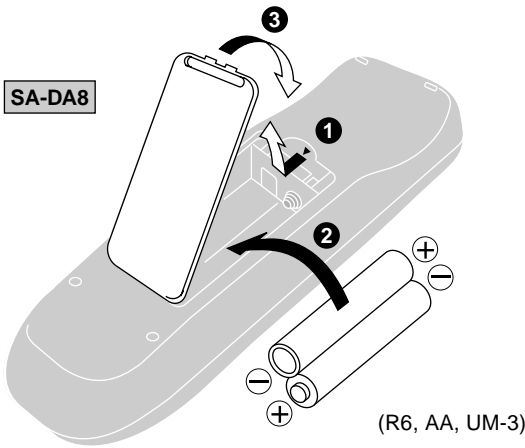
SA-DA8

(R6, AA, UM-3)

B

Remote control signal sensor

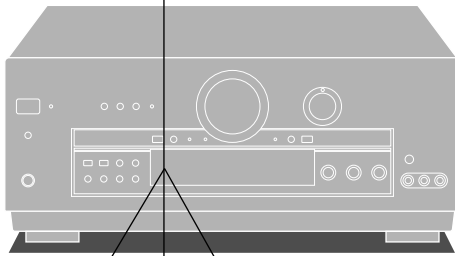

Transmission window

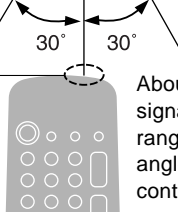

About 7 meters in front of the signal sensor. (The actual range will depend on the angle at which the remote control is used.)

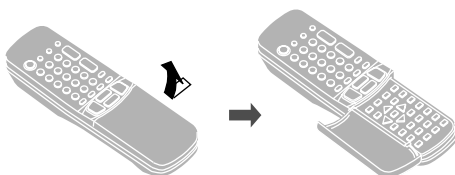
C

Concerning the remote control

A Battery installation

Use of batteries

- Align the poles (+ and -) properly when inserting the batteries. Press in and down towards the minus end.
- Do not mix old and new batteries or different types of batteries.
- Do not recharge ordinary dry cell batteries.
- Do not heat or disassemble the batteries. Do not allow them to contact flame or water.
- Remove the batteries if the unit is not to be used for a long time.
- Do not keep together with metallic objects such as necklaces.
- Do not use rechargeable type batteries.
- Do not use batteries if the covering has been peeled off.

Mishandling of batteries can cause electrolyte leakage which can damage items the fluid contacts and may cause a fire.

If electrolyte leaks from the batteries, consult your dealer.

Wash thoroughly with water if electrolyte comes in contact with any part of your body.

B Correct method of use

Operation notes

- Do not place obstacles between the remote control signal sensor and remote control unit.
- Do not expose the remote control signal sensor to direct sunlight or to the bright light of a fluorescent light.
- Take care to keep the remote control signal sensor and end of the remote control unit free from dust.
- If the unit is installed in a rack with glass doors, the glass doors' thickness or color might make it necessary to use the remote control a shorter distance from the unit.

To prevent damage

- Never place heavy items on top of the unit.
- Do not disassemble or reconstruct the unit.
- Do not spill water or other liquids into the unit.

C How to open the remote control **SA-DA10 only**

For your reference

This remote control can be used to operate the receiver you purchased and some other Panasonic and Technics cassette decks, MD decks, CD players, TVs, VCRs and DVD players, provided they are equipped with a remote control sensor.

SA-DA10 only

It is also possible to change-over the remote control code so that the remote control can operate TVs, VCRs and DVD players which have not been manufactured by this company (➔ pages 46-47).

Note

- For details on operating other equipment, see the instruction manual provided with specific unit.
- Some models cannot be operated by this remote control.
- Actual operations depend on your equipment and software.

Before use

Connections

Stereo phono cable (not included)

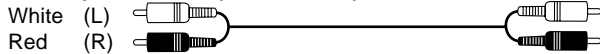

Video connection cable (not included)

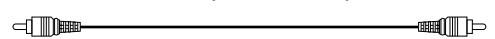

Turn off all components before making any connections.

To connect equipment, refer to the appropriate operating instructions.

Note

- Use digital connection to enjoy Dolby Digital or DTS (➔ page 20).
- Use analogue connection to enjoy sources that cannot be decoded on this unit and to record a source (➔ pages 22 and 48).

Connecting a DVD player

Optical fiber cable connection

Dust cap

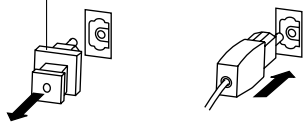

- Do not bend the optical fiber cable.
- If the digital optical connector is not going to be used, be sure to attach the dust cap to prevent exposure to dust.

Note

Dolby Digital RF (radio frequency) signals cannot be decoded with this unit.

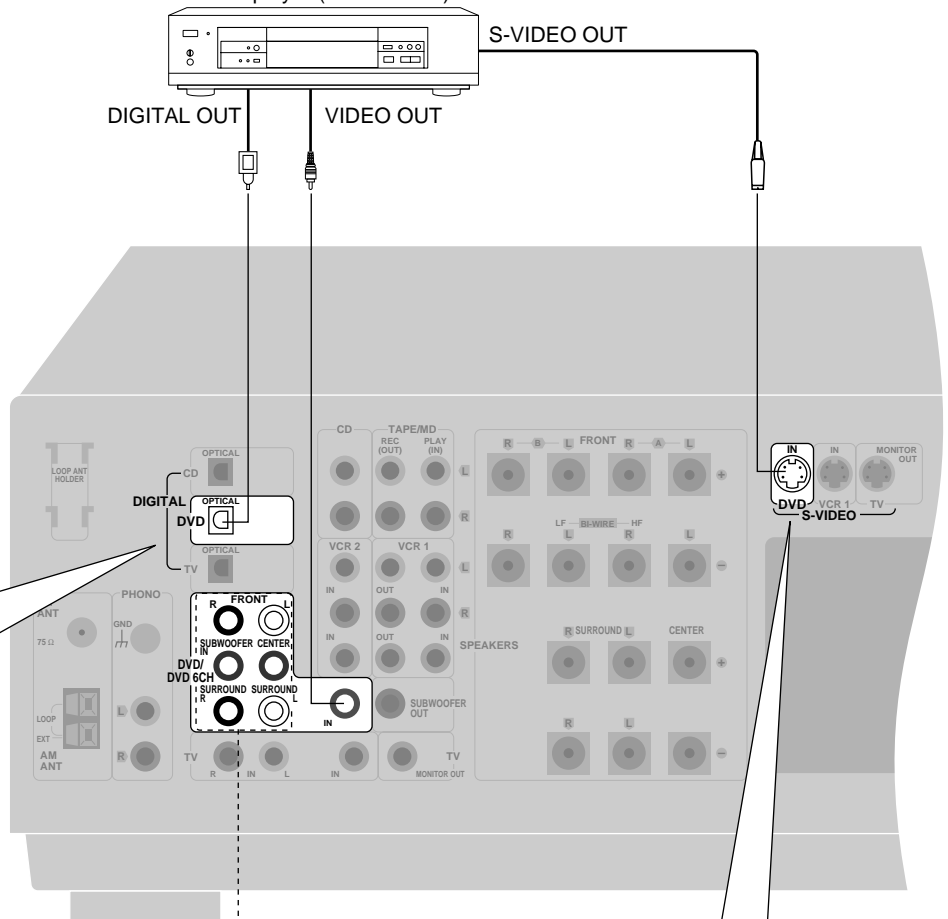
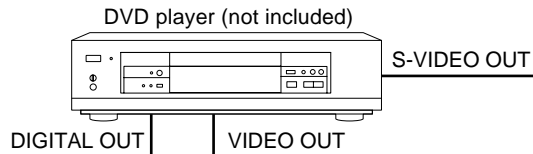

To connect analogue 6 channel

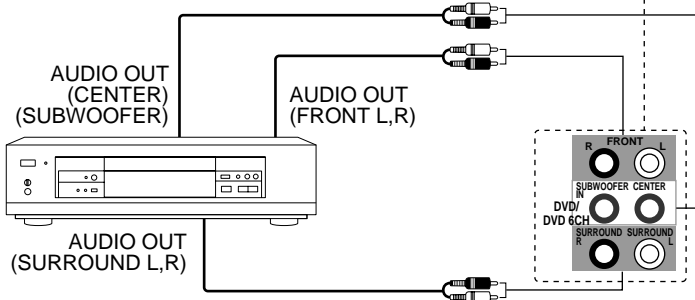

The S-VIDEO terminals

Connections through these terminals provide higher quality pictures than through the video terminal.

Note

When using S-VIDEO terminals, be aware that video signals input into the VIDEO terminals cannot be output from S-VIDEO terminals or vice versa.

Note

Connect to FRONT L, R if your DVD player does not have 6 channel output.

Optical fiber cable (not included)



S-VIDEO cable (not included)

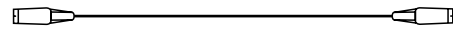

Connecting video equipment

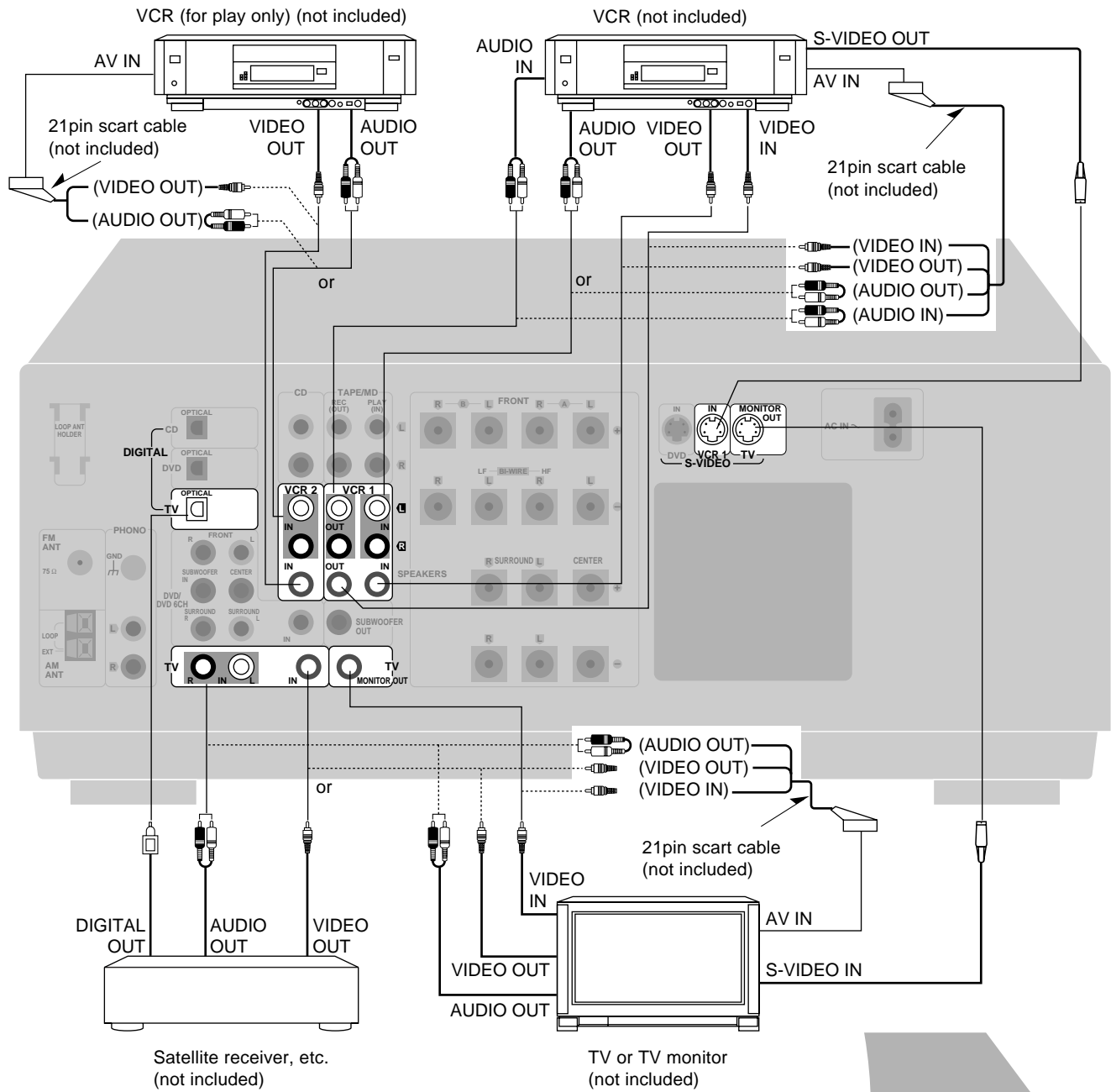

Connecting to the VCR 3 terminals on the front panel

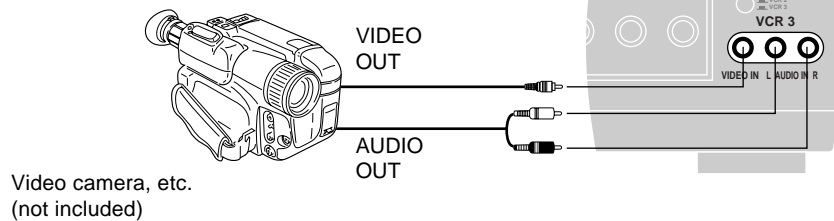

Connecting audio equipment

Stereo phono cable (not included)

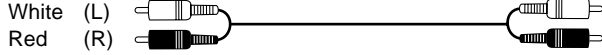

Optical fiber cable (not included)

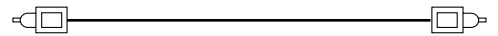

Turntable (not included)

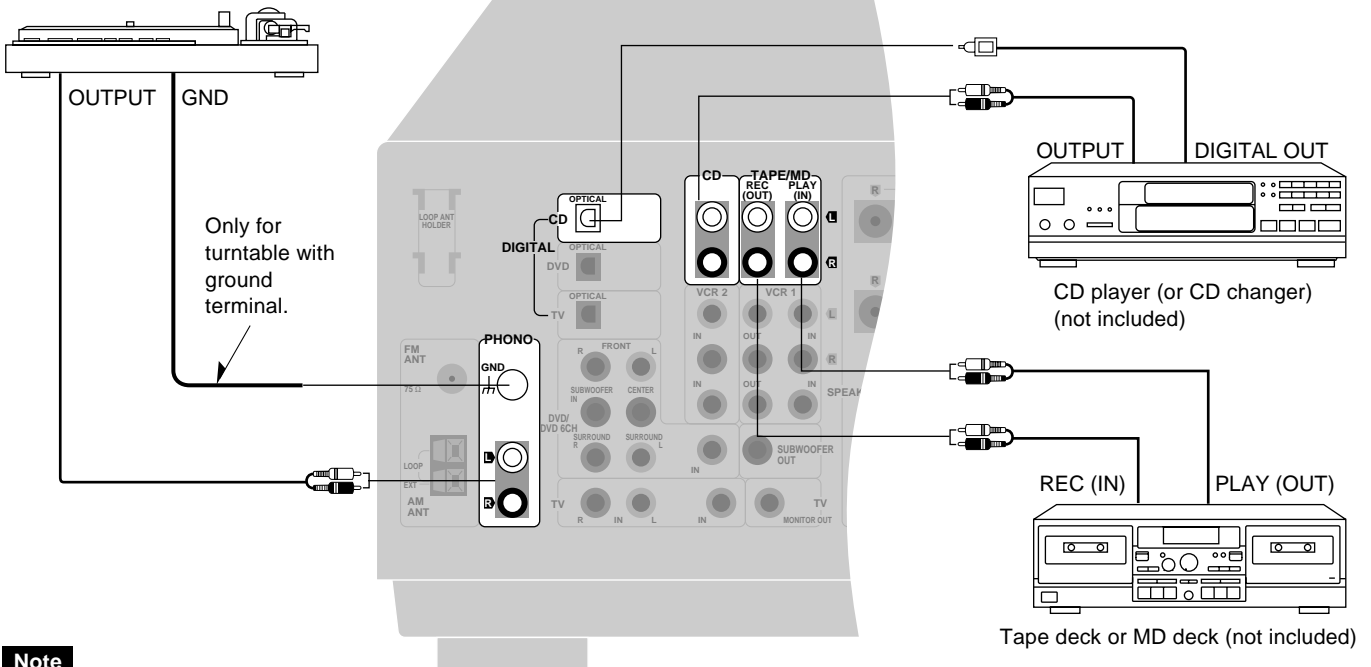

Note

If you want to connect a graphic equalizer, connect it to the TAPE/MD (for the United Kingdom) or TAPE (for Australia and New Zealand) terminals (➡ page 24).

Antenna connections

AM loop antenna

- Fit the AM loop antenna holder (included) onto the rear panel of this unit and then attach the AM loop antenna to the AM loop antenna holder (facing in the direction of best reception).
- Keep the antenna cord away from tape decks, DVD players, and other cords.

FM indoor antenna (included)

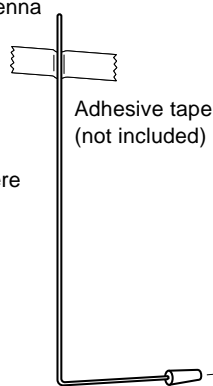

FM antenna

Fix the other end of the antenna where reception is best.

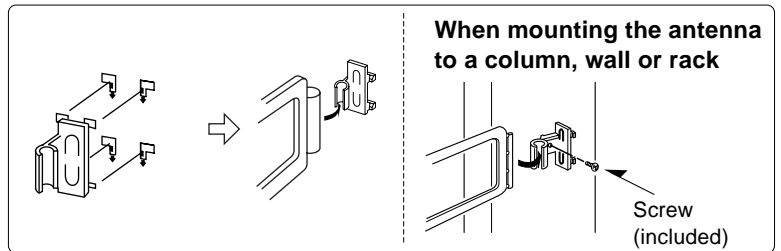

AM loop antenna (included)

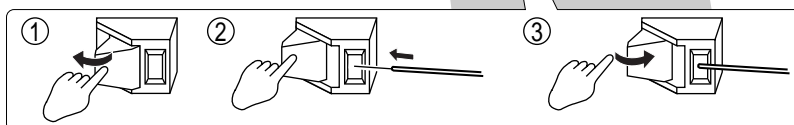

To connect an outdoor antenna

FM outdoor antenna

- Disconnect the FM indoor antenna.
- The antenna should be installed by a competent technician.

For the United Kingdom

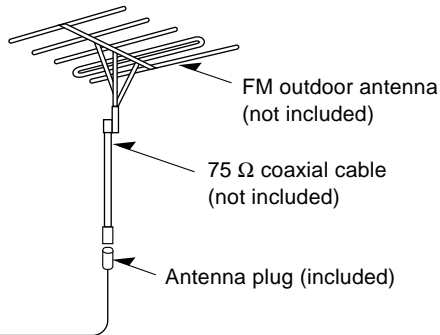

For Australia and New Zealand

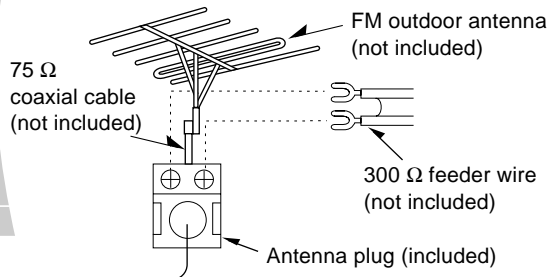

AM outdoor antenna

- Run a piece of vinyl wire horizontally across a window or other convenient location.
- Leave the loop antenna connected.
- Disconnect the antenna when the unit is not in use. Do not use the antenna during an electrical storm.

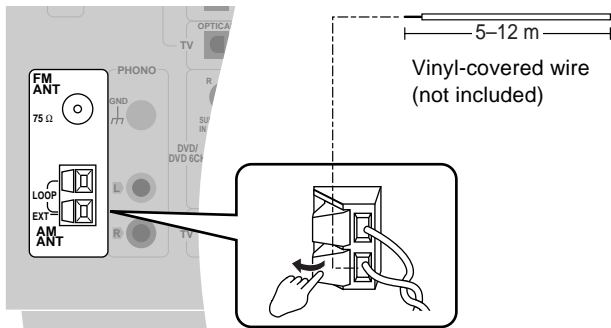

How to use the antenna plug (included)

For Australia and New Zealand

Two types of wire are most commonly used for connection from the antenna: 300 Ω parallel feeder wire or 75 Ω coaxial cable. For best resistance to outside interference, the use of 75 Ω coaxial cable is suggested.

• To connect a 75 Ω coaxial cable

- ① Remove a piece of the outer vinyl insulator.

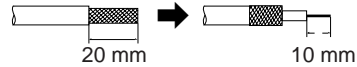

- ② Carefully pull the tabs apart to remove the cover.

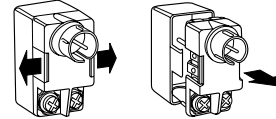

- ③ Remove the lead wire and clamp it with the plastic bar.

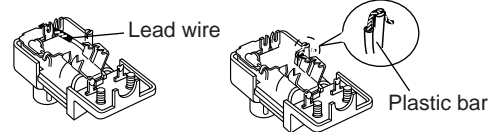

- ④ Install the coaxial cable.

Clamp the cable conductor, and wind it on so that it doesn't contact anything else.

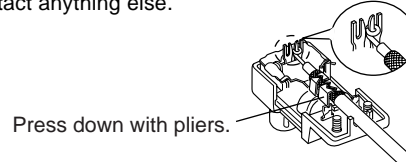

- ⑤ Attach the cover.

• To connect a 300 Ω feeder wire

Loosen the screws, connect the wires, and tighten the screws to secure the connection.

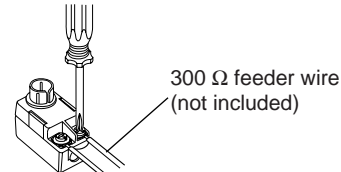

Connecting the AC mains lead and other information

Cooling fan

The cooling fan operates at high power output levels only.

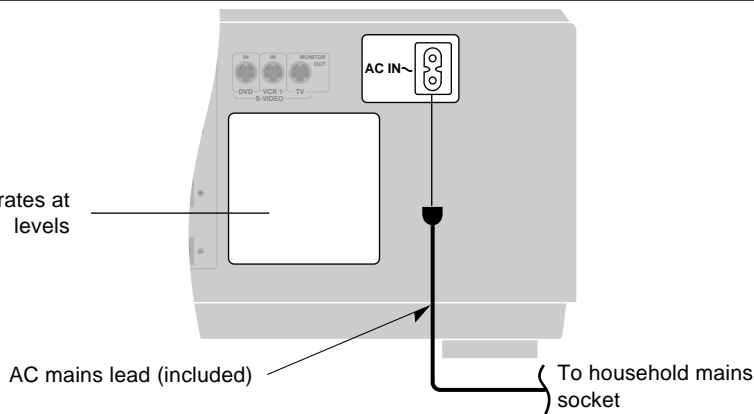

AC mains lead

Connect this lead only after all other cables and cords are connected.

Insertion of Connector

Even when the connector is perfectly inserted, depending on the type of inlet used, the front part of the connector may jut out as shown in the drawing. However there is no problem using the unit.

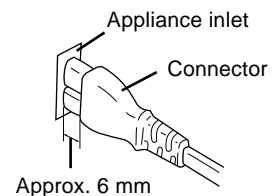

(FOR THE UNITED KINGDOM ONLY)
READ THE CAUTION FOR THE AC MAINS LEAD ON PAGE 3 BEFORE CONNECTION.

Note

The included AC mains lead is for use with this unit only. Do not use it with other equipment.

Speaker connections

Placement of speakers

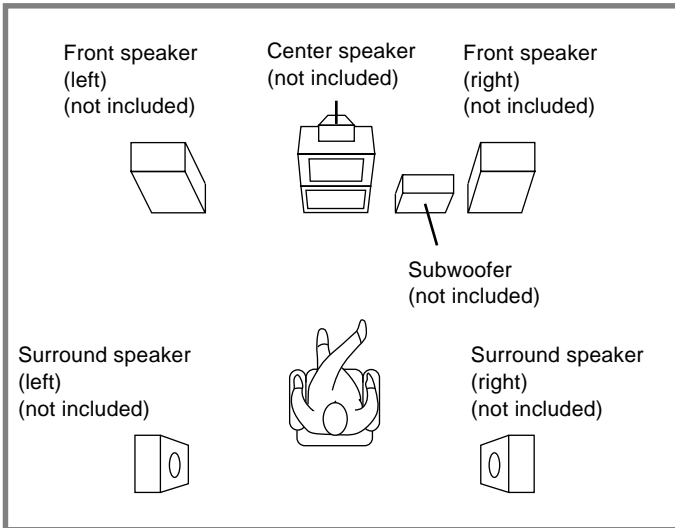

Front speakers

Place on the left and right of the TV at seated ear height so that there is good coherency between the picture and sound.

Center speaker

Place underneath or above the center of the TV. Aim the speaker at the seating area.

Surround speakers

Place on the side of or slightly behind the listening position, about one meter higher than ear level.

Subwoofer

The subwoofer can be placed in any position as long as it is at a reasonable distance from the TV.

Note that some experimentation can yield the smoothest low frequency performance. Placement near a corner can increase the apparent output level, but can result in unnatural bass.

Connecting speakers

Other connections are possible depending on your speaker system. See your speaker system's operating instructions for details.

Front speakers

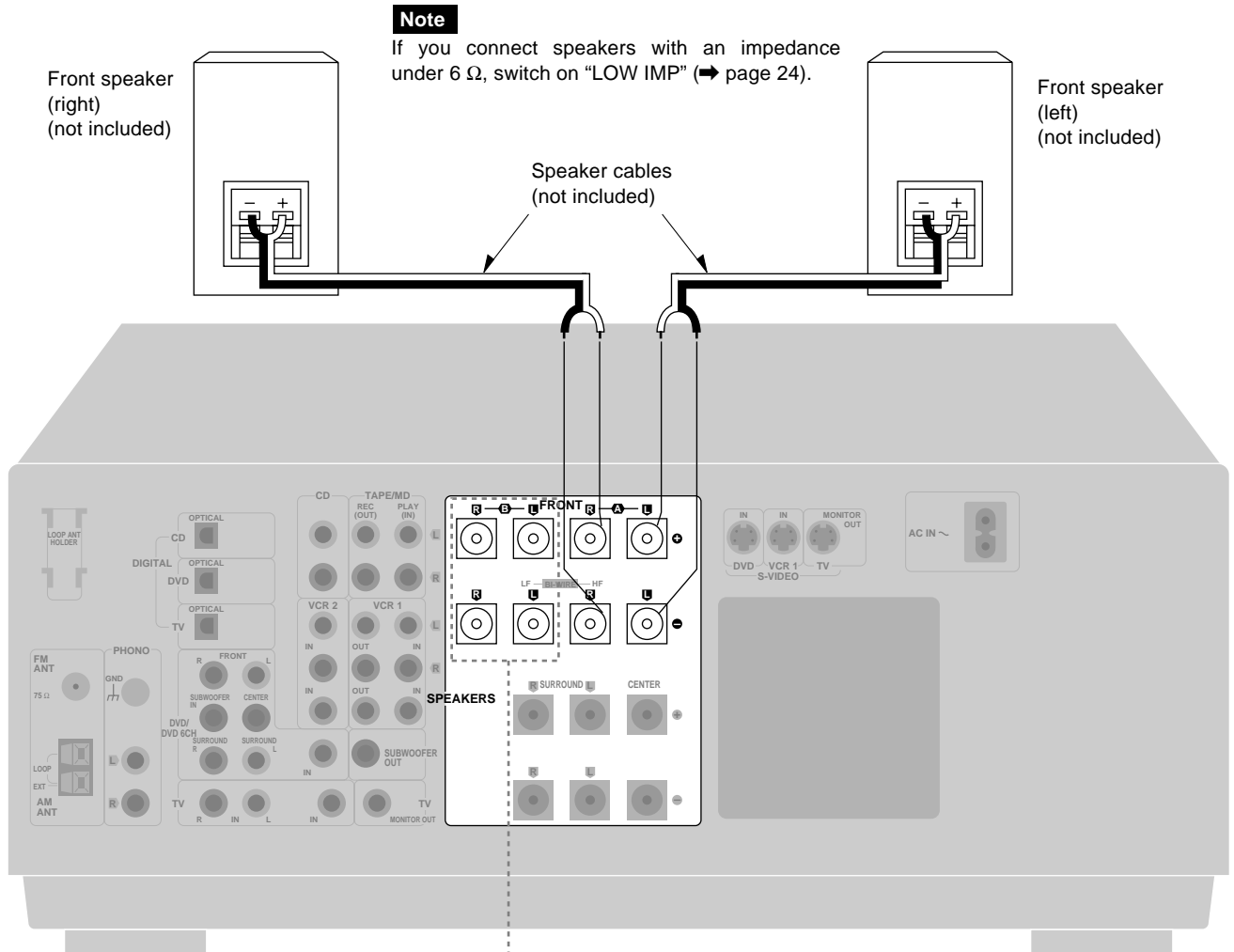

"B" terminals

For connection to a second pair of speakers.

Note

Use the A terminals to enjoy SURROUND, SFC and DVD 6CH INPUT.

Speaker impedance:

A or B: $4-16 \Omega$
A and B: $8-16 \Omega$

Bi-wiring connection

Note

When bi-wiring, use speakers designed for that purpose that have combined impedance of 6–16 Ω.

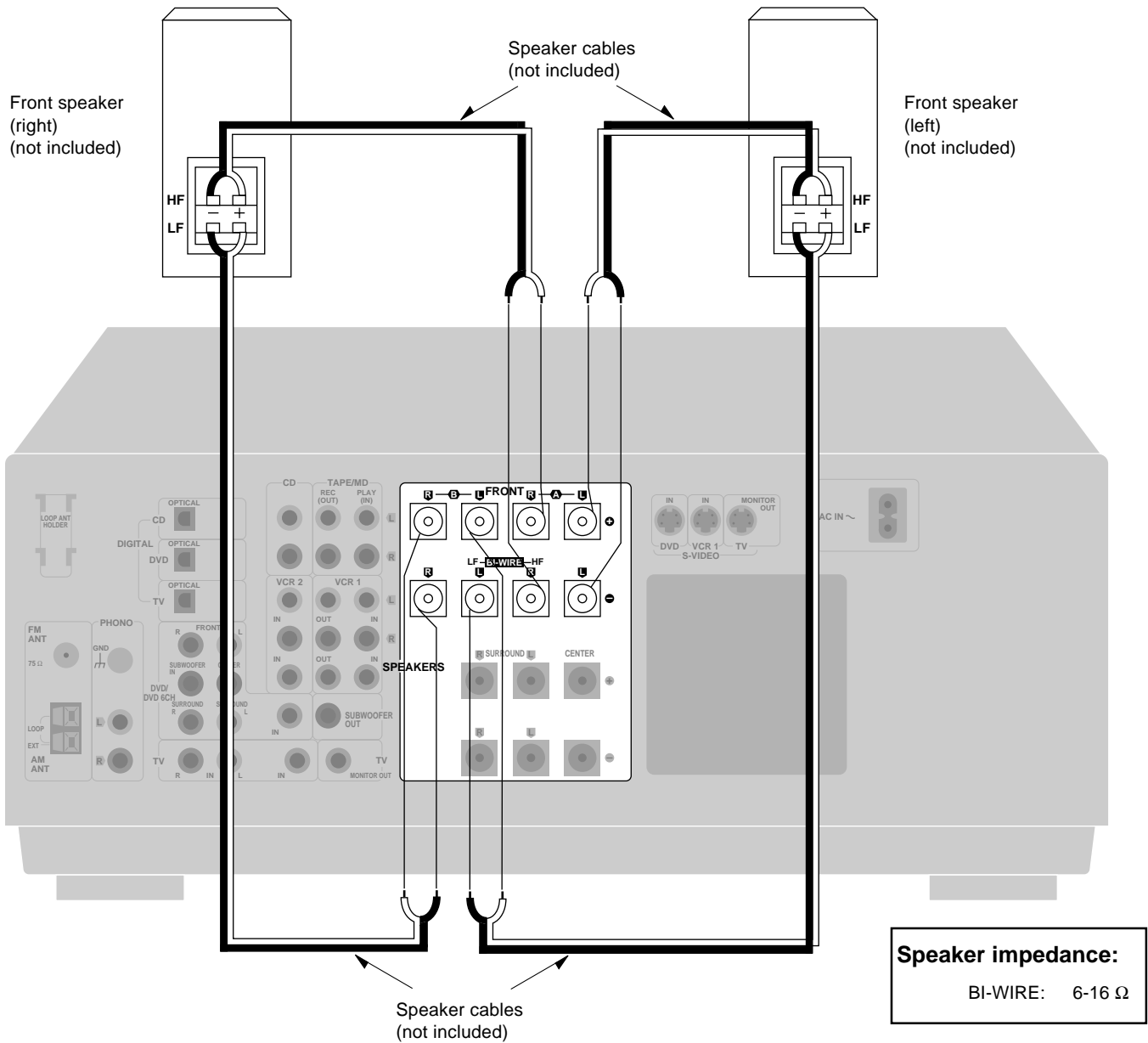

Connecting the cables

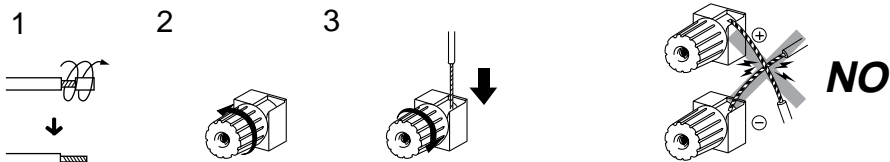

Speaker connections

Center speaker

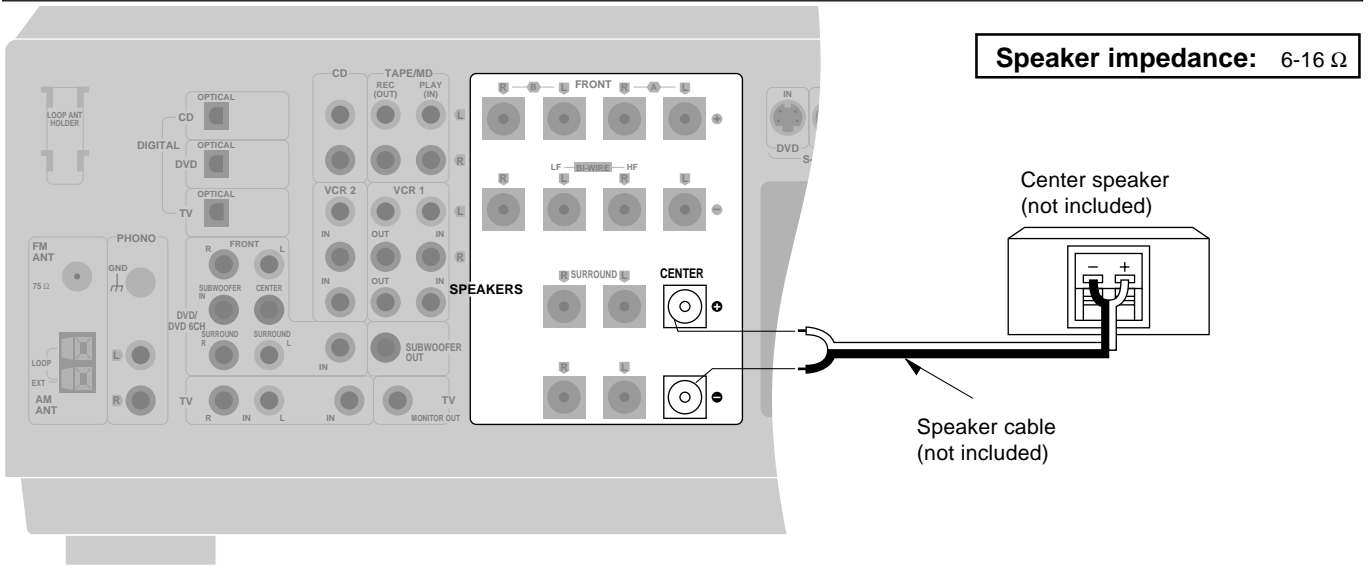

Surround speakers

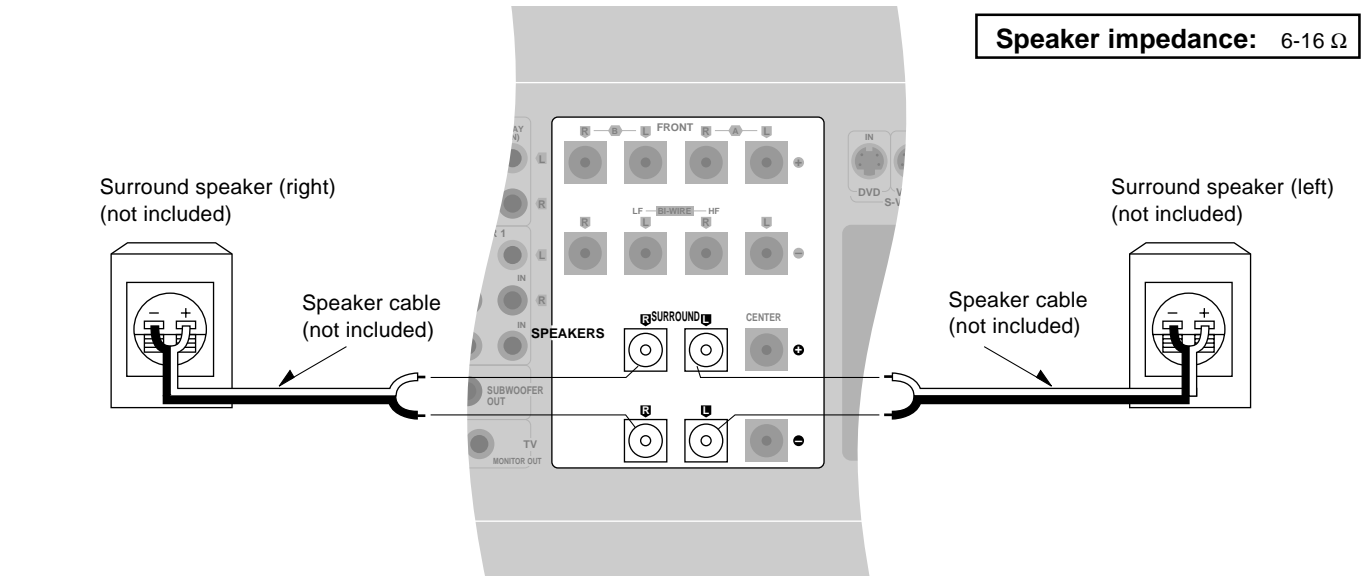

Subwoofer

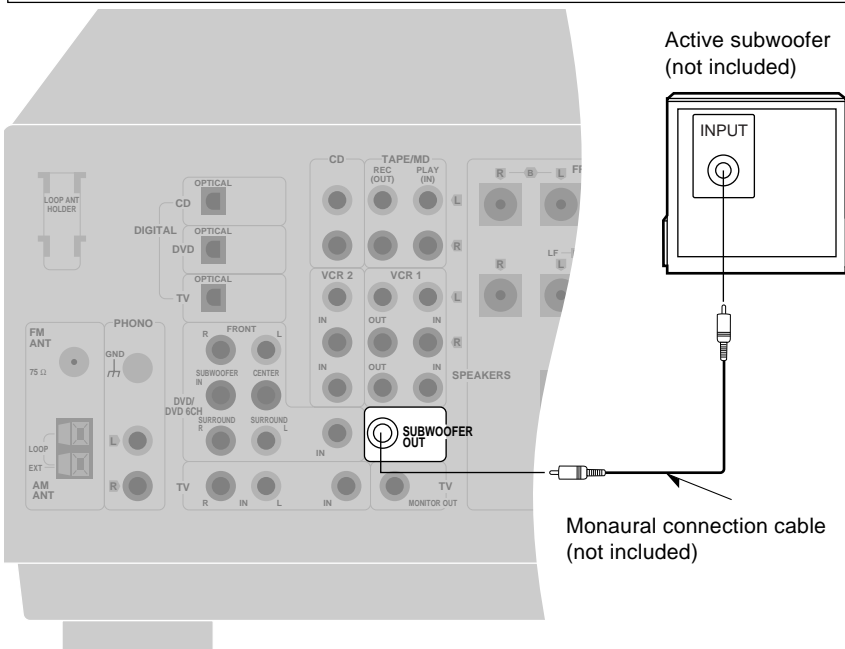

Note

This receiver does not have an amplifier for the subwoofer.

To connect a passive subwoofer

- Connect another amplifier and connect the subwoofer to it.

Or

- Connect a passive subwoofer that has front speaker terminals (See the operating instructions of the speaker system for details.)

Preparatory steps

Speaker settings

These settings should be done to get the most from the unit's DSP reproduction modes (➔ pages 20 and 21).

In SIZE

Set the type (LARGE or SMALL) and presence (NONE, YES or NO) of your speakers. Select "LARGE" if the speakers can produce bass (below around 100 Hz). Select "SMALL" if the speakers cannot produce bass. Select "NONE" if center and surround speakers aren't connected. Select "NO" if a subwoofer isn't connected. The sound for those speakers is then produced through the front speakers.

In DISTANCE

Enter the distance of front, center surround speakers from the listening position so the sound from the speakers reaches the listening position at the same time. The unit calculates the delay time for the center and surround speakers based on these distances.

In FILTER

Enter the cutoff frequency for your subwoofer based on the bass capability of your front speakers

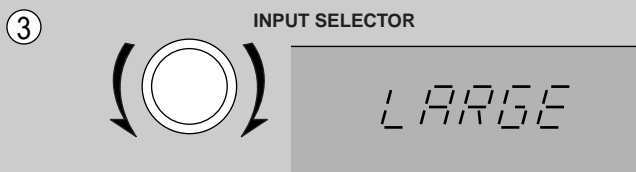
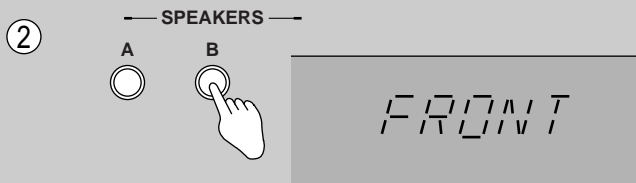
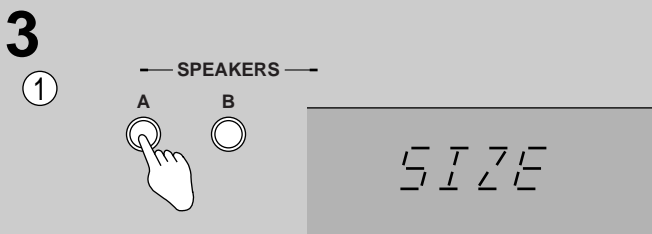
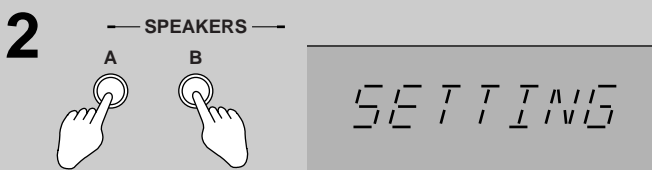
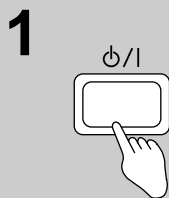
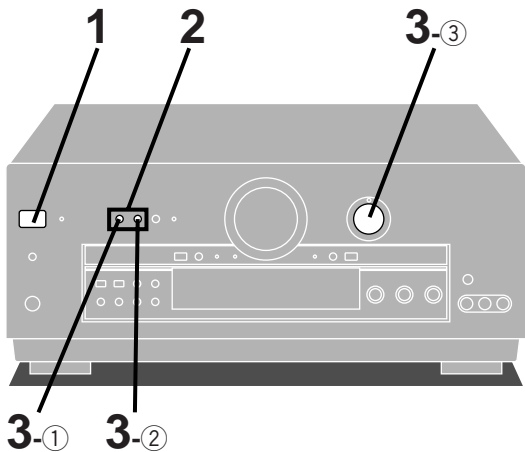

1 Press [⏻/⏪].

2 Press [A] and [B] at the same time.

"SETTING" appears on the display.

3 To set "SIZE"

① **Press [A] to select "SIZE".**

Each time you press the button, the display switches as follows.

SIZE → DISTANCE → FILTER → DR COMP

② **Press [B] to select the speaker channel to be set.**

Each time you press the button, the display switches as follows.

FRONT → CENTER → SURROUND → SUB-WFR

SUB-WFR=SUBWOOFER

③ **Turn [INPUT SELECTOR] to set the type (LARGE, SMALL) and presence (NONE, YES or NO) of the speaker.**

Each time you turn the selector, the display switches as follows.

FRONT:

SMALL ↔ LARGE

CENTER, SURROUND:

NONE ↔ SMALL ↔ LARGE

SUBWOOFER:

NO ↔ YES

The factory settings are as follows.

Front, center and surround speakers: LARGE
Subwoofer: YES

④ Repeat steps ② and ③ to complete the size settings for all speakers.

(Continued on next page)

Preparatory steps

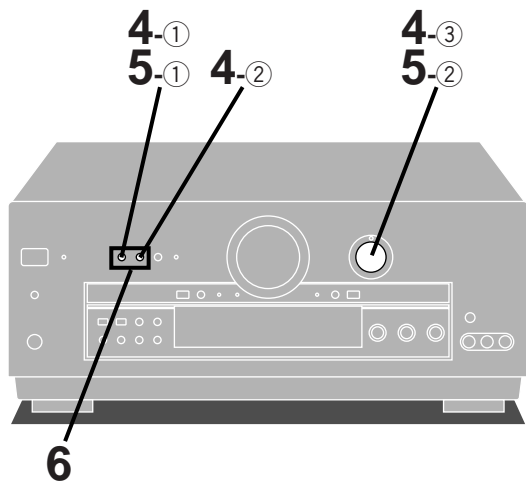

4 To set "DISTANCE"

① Press [A] to select "DISTANCE".

② Press [B] to select the speaker channel to be set.

Each time you press the button, the display switches as follows.

FRONT → CENTER → SURROUND
↑

③ Turn [INPUT SELECTOR] to set the distance.

Distance can be set at 0.1 m intervals between 1.0 to 10.0 m.

The factory settings are as follows.

Front and center speakers: 3.0 m

Surround speakers: 1.5 m

④ Repeat steps ② and ③ to complete the size settings for the front, center and surround speakers.

5 To set "FILTER"

① Press [A] to select "FILTER".

② Turn [INPUT SELECTOR] to set the cut off frequency.

Each time you turn the selector, the display switches as follows.

100 ↔ 150 ↔ 200

The factory setting is 100 Hz.

6 Press [A] and [B] at the same time.

"COMPLETE" appears on the display.

If you allow about 10 seconds to elapse between settings, the procedure is canceled, all settings are returned to how they were, and the previous display is restored. Begin again if this occurs.

For your reference

The settings remain as they are until changed by the above procedure, even after the power has been turned off.

4

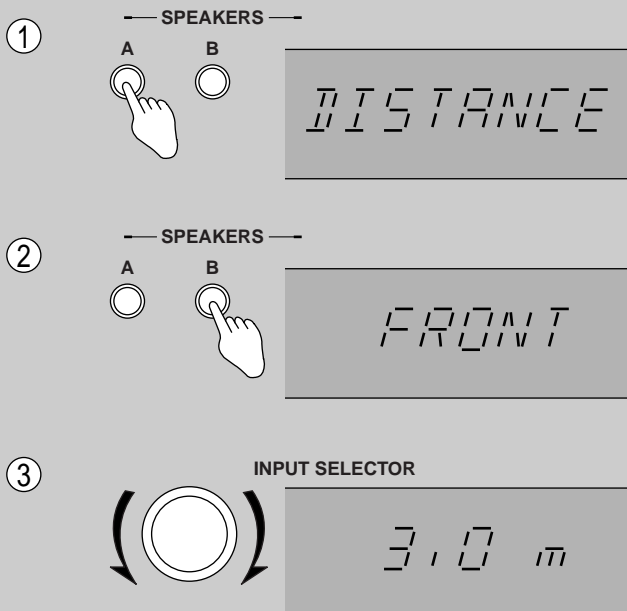

5

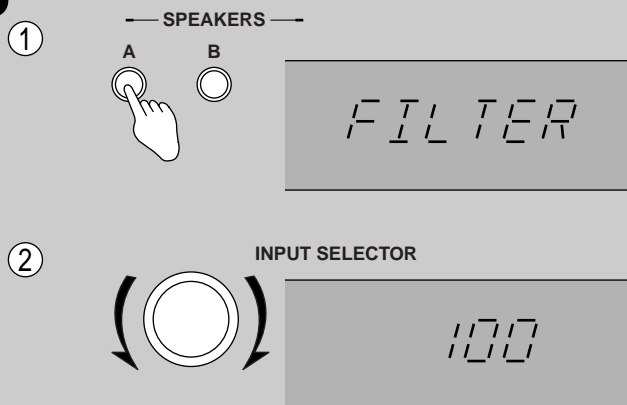

6

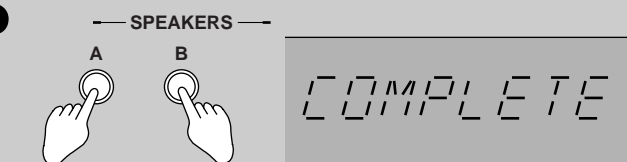

Preparatory steps

Adjusting speaker output level

Adjust speaker level so the output from all the speakers is the same apparent level when sitting where you would normally enjoy a source.

1 Press [A] or [BI-WIRE] to turn on SPEAKERS.

A or BI-WIRE refer to the speaker terminals at the rear of the unit.

You cannot adjust output level when SPEAKERS B is selected.

2 by remote control only

Press [TEST] to output the test signal.

"TEST" appears on the display.

The signal is output from each speaker in order for about two seconds each:

L: Front speaker (left)

C: Center speaker

R: Front speaker (right)

RS: Surround speaker (right)

LS: Surround speaker (left)

SW: Subwoofer

Speakers set as "NONE" or "NO" are skipped.

Note

DSP sound mode switches to SURROUND mode when the test starts.

3 by remote control

Press [VOLUME (+ or -)] (SA-DA10) or [VOL (- or +)] (SA-DA8) to set the volume level normally used for enjoying the source.

Note

Use [BALANCE] if the left right balance of the front speakers is off.

4 by remote control only

Press [LEVEL] to select the speaker channel to adjust.

The current level appears on the display.

Press again to change the speaker channel.

Speakers set as "NONE" or "NO" are skipped.

5 by remote control only

Press [+] or [-] to adjust the level to the same apparent level as the front speakers.

The four channels can be adjusted between -10 dB and +10 dB, with zero being the current level of the front speakers.

6 Repeat 4 and 5 for each speaker channel.

To stop the test signal

Press [TEST].

Note

The test signal will not be output if VGCA is ON (→ page 27).

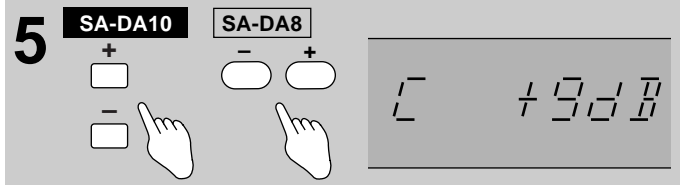
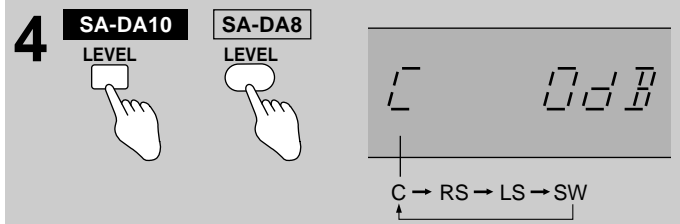
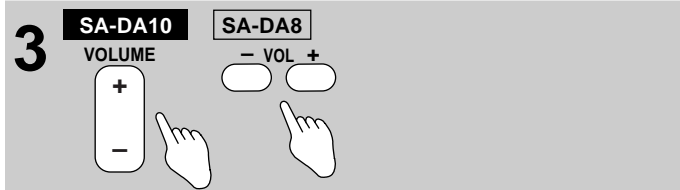
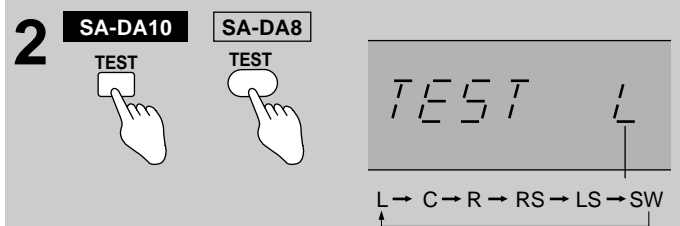
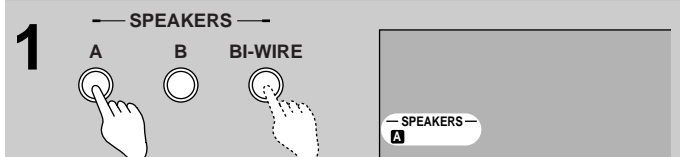
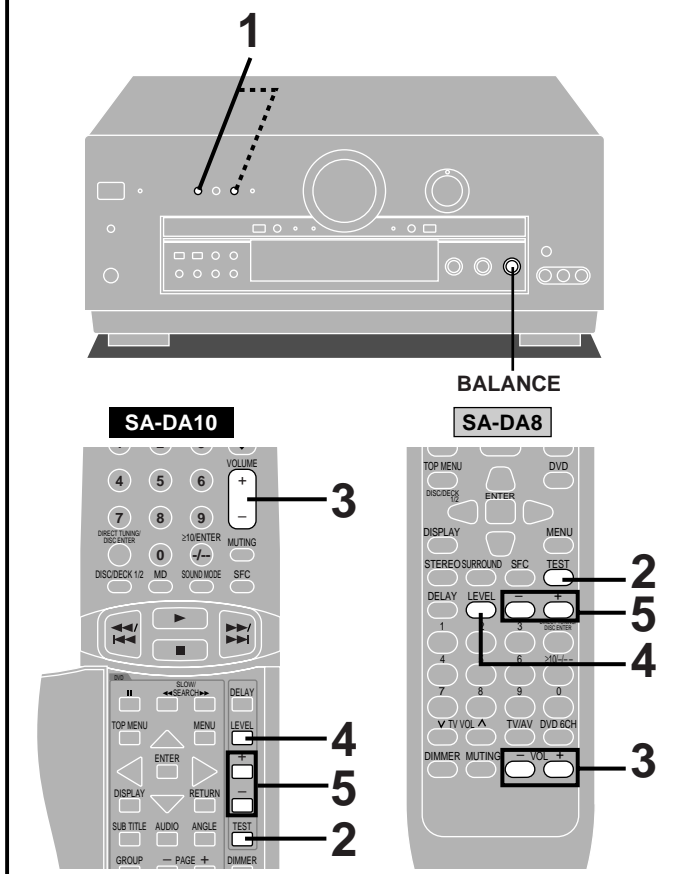

DSP sound modes

This unit's digital signal processor (DSP) has the following three modes—STEREO, SURROUND and SFC.

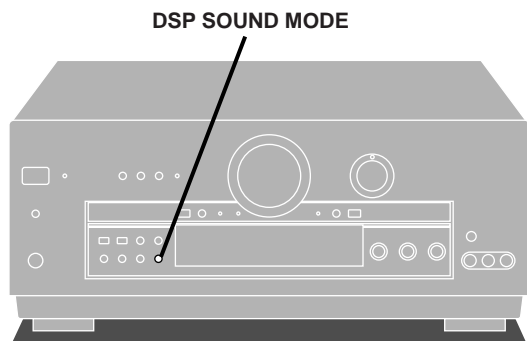

A STEREO mode

Use this mode when you want to listen to stereo sources, whether they are digital or analogue, or when you want to play Dolby Digital or DTS sources through two channels. The sounds usually fed through the other speakers are down-mixed so they are output through the left and right front speakers. There may be some change in the overall sound when surround sources are down-mixed.

B SURROUND mode

By selecting this mode while digital input is being used, the unit automatically determines the kind of digital source being used (Dolby Digital, Dolby Surround, or DTS), and processes it accordingly. Select this mode also when you are playing an analogue source, VCR for example, that has been recorded in Dolby Surround.

Software with the following marks can be played back in this mode.



The following indicators light depending on the source.

DIGITAL

When playing Dolby Digital sources.

When playing DTS sources.

PRO LOGIC

When playing analogue sources.

When playing digital sources with PCM signals.

When playing Dolby Digital sources that contain Dolby Pro Logic.

About the program format indicators (L, C, R, LS, S, LFE, RS)

The program format indicators light up to indicate the channels contained in the digital input signal.

These indicators do not light when input is analogue.

L: Front channel (left)

C: Center channel

R: Front channel (right)

LS: Surround channel (left)

RS: Surround channel (right)

If the surround channel is monaural, "S" is displayed instead of LS and RS.

"LFE" (Low Frequency Effect) is a channel for the deep-bass effect.

A

DSP SOUND MODE



B

DSP SOUND MODE



Dolby Digital

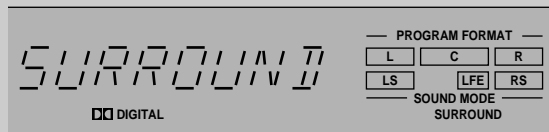

DTS

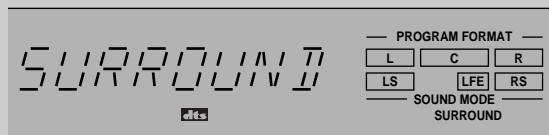

Dolby Pro Logic



Manufactured under license from Dolby Laboratories. "Dolby", "Pro Logic" and the double-D symbol are trademarks of Dolby Laboratories. Confidential unpublished works. © 1992-1997 Dolby Laboratories. All rights reserved.

Manufactured under license from Digital Theater Systems, Inc. "DTS" and "DTS Digital Surround" are trademarks of Digital Theater Systems, Inc. © 1996 Digital Theater Systems, Inc. All rights reserved.

DSP sound modes

SFC modes

by remote control only

Enjoy an enhanced sound experience with greater presence and spread by using these SFC (sound field control) modes with stereo sources.

Choose from the following modes.

HALL

Imparts the reflection and spread of a large concert hall.

CLUB

Conveys the exciting and intimate atmosphere of a jazz club.

LIVE

Brings you up close for “live” stage performance and smoother vocals.

THEATER

Recreates natural sound ambience and direction.

SIM SURR (Simulated Surround)

Heightens the sensation of expanded space with stereo sources, and augments monaural sources.

If the beginning of a track is cut off when playing CDs

The beginning of a track may be cut off when you play CDs in STEREO mode.

You can solve this by engaging the PCM FIX mode.

Press and hold [DIGITAL INPUT] for four seconds in STEREO mode.

“PCM FIX” appears on the display.

Note

- This mode can be selected for each source, but is canceled when the unit is turned off.
- The PCM FIX mode can be selected in STEREO mode only.
- Dolby Digital and DTS sources cannot be played while PCM FIX mode is on.
- Noise can occur if DTS sources are played while PCM FIX mode is engaged. To avoid this, be sure to turn PCM FIX mode off after use.

If the DTS source you are playing is not recognized

The DTS source may not be recognized if you select SURROUND mode.

You can solve this by engaging the DTS FIX mode.

Press and hold [DIGITAL INPUT] for four seconds in SURROUND mode.

“DTS FIX” appears on the display.

Note

- This mode can be selected for each source, but is canceled when the unit is turned off.
- The DTS FIX mode can be selected in SURROUND mode only.
- Dolby Digital and PCM sources cannot be played while DTS FIX mode is on.
- Noise can occur if Dolby Digital and PCM sources are played while DTS FIX mode is engaged. To avoid this, be sure to turn DTS FIX mode off after use.

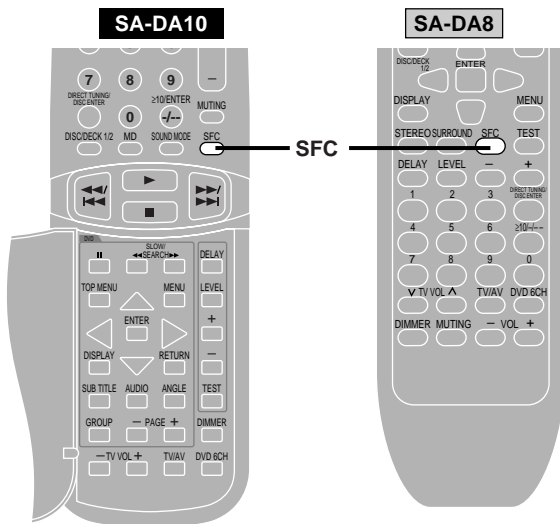
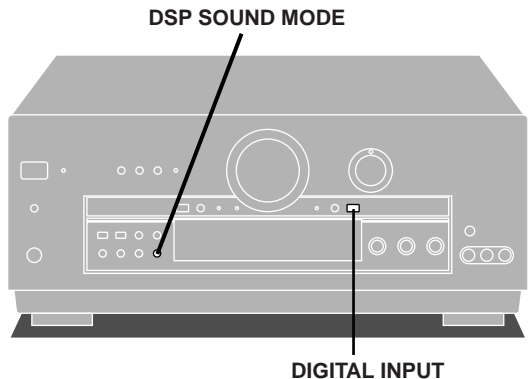

DSP SOUND MODE



SA-DA10

SFC



SA-DA8

SFC

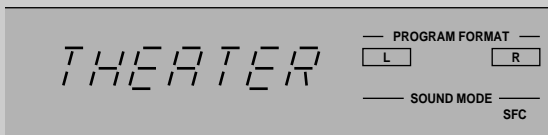
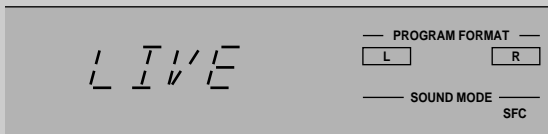
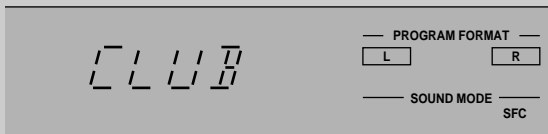
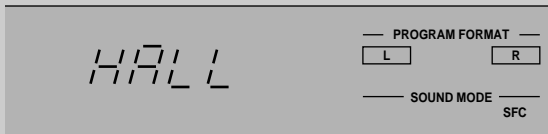

Enjoying the sounds

Preparation: Set [VOLUME] to the "MIN" position.

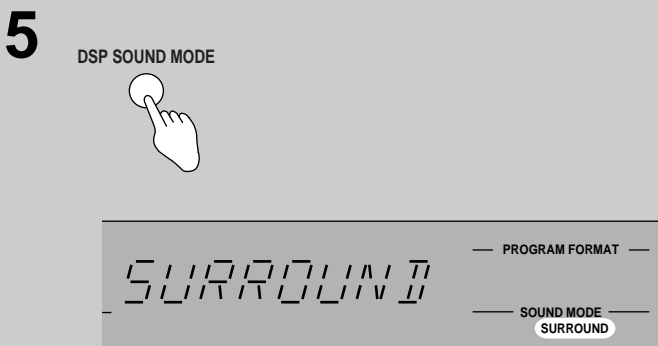
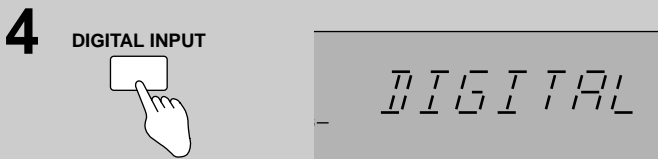
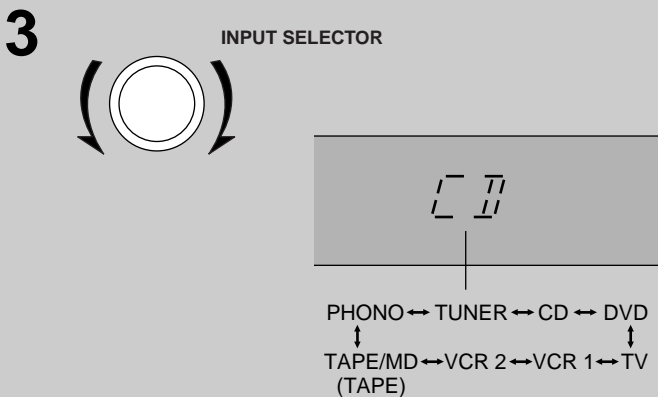
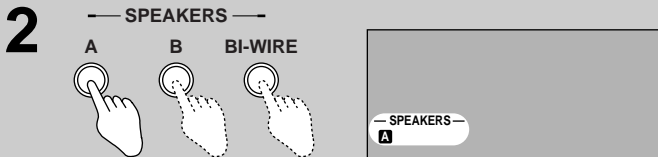
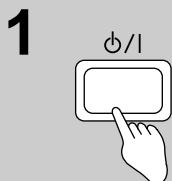
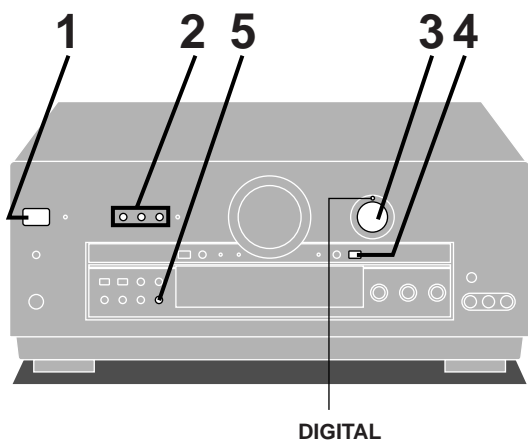

1 Press [POWER].

2 Select the speaker system(s) to be used.

A, B and BI-WIRE refer to the speaker terminals at the rear of the unit.

BI-WIRE and A, or BI-WIRE and B cannot be used at the same time.

"SURROUND" and "SFC" cannot be turned on if [B] is pressed.

If the button is pressed once more, the indicator will switch off and no sound will be heard from the speakers.

3 Turn [INPUT SELECTOR] to select desired source.

(Refer to the appropriate operating instructions for details.) Each time the selector is turned the display switches.

Note

Turn on the TV and select the input mode to suit the source (e.g. TV, VIDEO).

4 (only if you select TV, CD or DVD in the above step) Press [DIGITAL INPUT] to select the desired input mode.

Each time you press the button, the display switches as follows.

DIGITAL ↔ ANALOG

The "DIGITAL" indicator lights when "DIGITAL" selected.

5 Press [DSP SOUND MODE] to select the desired mode.

The SOUND MODE indicator corresponding to the selected mode lights and that mode is displayed.

Note

- Be sure to select the mode appropriate to the source you are playing (➔ pages 20 and 21).
- Dolby Digital and DTS sources cannot be played with the SFC modes.

(Continued on next page)

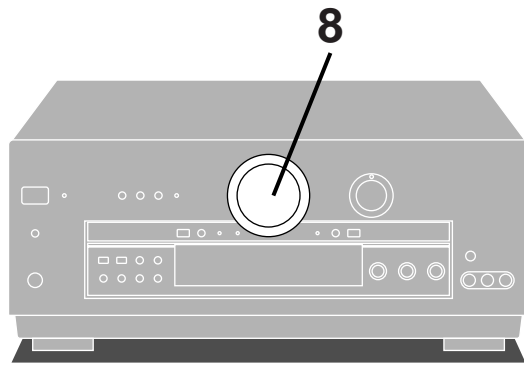

SA-DA10

SA-DA8

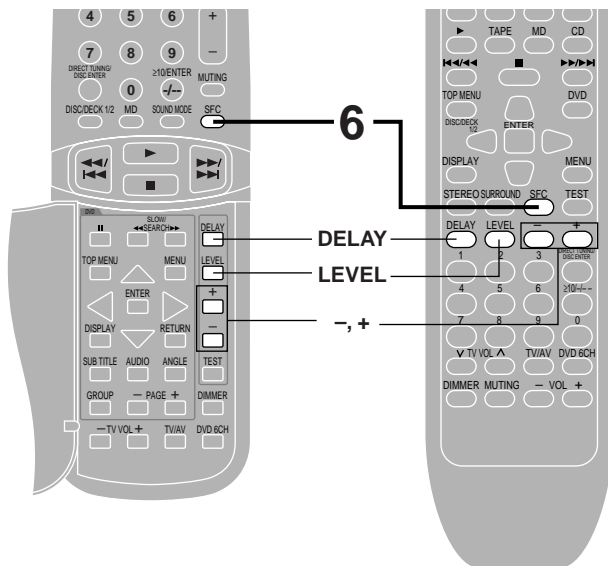

Enjoying the sounds

6 (if you selected SFC in step 5)

by remote control only

Press [SFC] to select the desired SFC mode.

The mode changes each time you press the button while the modes are displayed.

7 Start the source.

8 Adjust the volume.

While using the SFC modes

To adjust speaker level by remote control only

① Press [LEVEL] to select the speaker channel to adjust.

Each time the button is subsequently pressed, the speaker whose level is to be set is selected in the listed sequence.

C → RS → LS → SW

Speakers for which "NONE" or "NO" has been set are skipped.

② Press [+] or [-] to adjust the output level.

Channels C, RS, LS, and SW can be adjusted between -10 dB and +10 dB.

To adjust delay time by remote control only

You can adjust surround channel only.

Adjust the delay time of the sound from the surround speakers to produce the proper effect.

① Press [DELAY].

When you press the button, the current delay time is displayed.

② Press [+] or [-] to set the time.

Select a delay time to suit your individual needs.

Delay time can be set at 10 milliseconds (ms) intervals between 10 and 100 ms.

The factory settings for each mode are 50 ms.

For your reference

Speaker level and delay time can be set for each SFC mode.

When you finish listening

Be sure to reduce the volume and press [⏻/⏸] to switch the unit to standby.

For your reference

● If you are using a VCR (connected to VCR 1) and you select TAPE/MD (for the United Kingdom), TAPE (for Australia and New Zealand), CD, TUNER, or PHONO

The picture will remain on the screen.

● About the DSP sound modes

The DSP sound modes can be set for each source. Once you have set the mode for a source, the mode is engaged whenever that source is selected.

These modes are automatically switched to STEREO if SPEAKERS B is selected or both SPEAKERS A and B or BI-WIRE are turned off. When SPEAKERS B is turned off or SPEAKERS A or BI-WIRE is selected, the mode is switched back to the latest mode.

● Only Dolby Digital, DTS or PCM signals (44.1 kHz or 48 kHz) can be reproduced through the digital terminal

The digital input signal of sampling frequencies 96 kHz or 192 kHz and other signal formats such as MPEG cannot be reproduced on this unit.

6

SA-DA10



SA-DA8

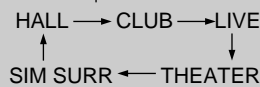

8

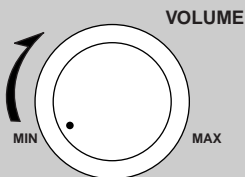

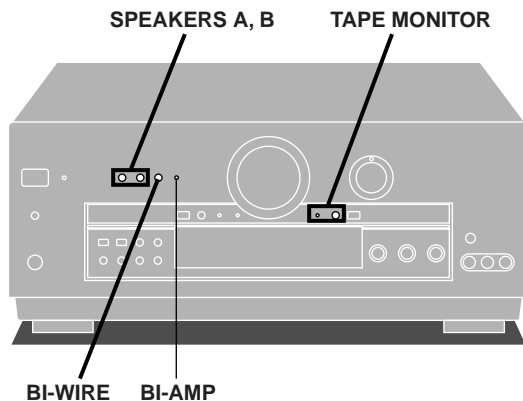

A To enjoy bi-amp sound

By using the bi-wiring feature of this unit to connect your speakers, you are able to take advantage of two separate amplifiers for the high frequency and low frequency ranges. This enables more highly defined sound reproduction of the two ranges thus producing high quality bi-amp stereo sound.

Ensure “BI-AMP” lights when [BI-WIRE] is selected.

BI-AMP will turn off and the indicator will go out in the following cases

- If any of the DSP sound modes are turned on.
- If DVD 6CH INPUT is selected.

Note

- Before pressing [BI-WIRE], connect speakers designed for bi-wiring using bi-wiring connection.
- Do not select [BI-WIRE] if you have connected two sets of speakers to the A and B speaker terminals.

B For front speakers with an impedance under 6 Ω

Press and hold [A] or [B] until “LOW IMP” lights up on the display.

If even one of the speakers being used has an impedance under 6 Ω, press and hold down either [A] or [B] for 4 seconds or more to set the impedance on the main unit to LOW.

(Press and hold down once again for 4 seconds or more to turn it off.)

Note that when “LOW IMP” is on, SPEAKERS A and B cannot both be used at the same time.

To change speakers:

e.g. To use SPEAKERS B, press [A] (“A” goes out), and then press [B] to activate SPEAKERS B.

C To use TAPE MONITOR

{For use when you have connected a graphic equalizer to the TAPE/MD (for the United Kingdom) or TAPE (for Australia and New Zealand) terminals.}

Press [TAPE MONITOR].

The “TAPE MONITOR” indicator lights and the tape monitor comes on.

Sources other than TAPE/MD (for the United Kingdom) or TAPE (for Australia and New Zealand) can still be selected with [INPUT SELECTOR] while the “TAPE MONITOR” indicator is on.

Press [TAPE MONITOR] again to turn the tape monitor off.

(⇒ See “Making a recording” on page 48 for details on how to use the tape monitor during recording.)

Note

- The tape monitor cannot be used when TV, DVD, or CD digital input is being used.
- If you are using the tape monitor and you select a digital input source, the tape monitor switches off.
- Depending on the settings on the graphic equalizer, there may be some distortion.

A

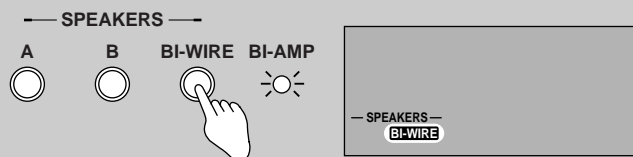

B

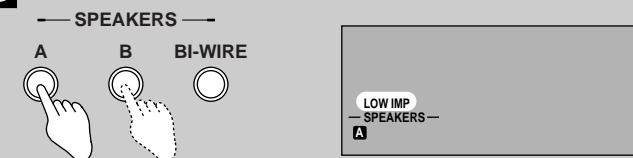

C

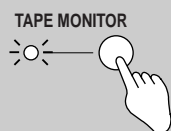

A To adjust the tone quality

Turn [BASS] to adjust the bass.
Turn [TREBLE] to adjust the treble.

B To adjust the sound balance

Turn [BALANCE] to adjust the left/right sound balance.

C When using the VCR 3 terminals

This button only works when "VCR 2" is selected as the input source.

When you have connected a VCR to the VCR 2 terminals on the rear of the unit, select "■ VCR 2".

When you have connected equipment to the VCR 3 terminals on the front of the unit, select "■ VCR 3".

Select "■ VCR 2" or "■ VCR 3."

FRT-VCR 3=FRONT VCR 3

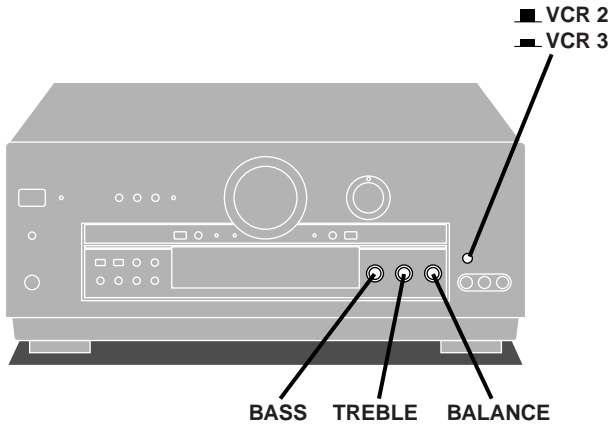

A

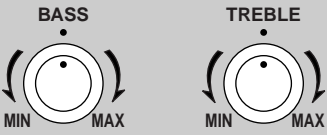

B



C

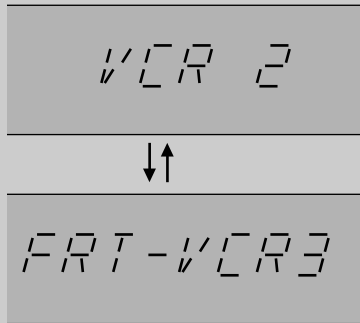
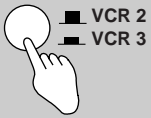

Switching DVD analogue input

Use analogue input to enjoy the high-quality, 96 kHz or 192 kHz linear PCM and multiple channel linear PCM audio found on some DVD-Video and DVD-Audio.

Select the analogue input mode to suit the source.

DVD: For two-channel audio. Use the bi-amp to enhance your audio experience (➔ page 24).

DVD 6CH: For multiple channel audio.

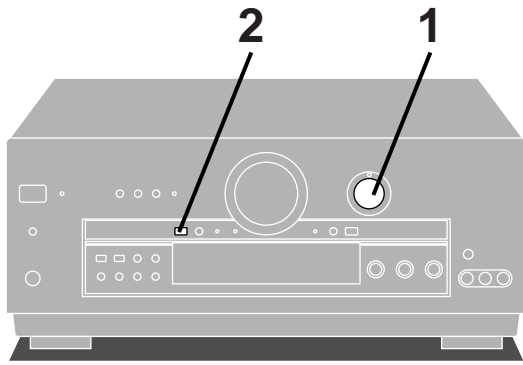

1 Turn [INPUT SELECTOR] to select “DVD”.

2 Press [DVD 6CH INPUT].

The mode changes each time you press the button.
DVD 6CH ↔ DVD

If you press this button while another source (CD, PHONO, etc.) is selected, the receiver switches the source to DVD and engages the DVD 6CH INPUT mode.

3 Start the desired source.

Follow your equipment’s operating instructions.

Note

- If you select SPEAKERS B or turn the speakers off, DVD 6CH switches to DVD and the STEREO DSP sound mode turns on. The mode is restored when you turn SPEAKERS B off or turn SPEAKERS A or BI-WIRE on.
- You cannot select any of the DSP sound modes while in the DVD 6CH INPUT mode.
- BI-AMP and DVD 6CH INPUT cannot be used at the same time.
If you are using BI-AMP and you select DVD 6CH INPUT, BI-AMP will turn off and the “BI-AMP” indicator will go out.
- Any speaker settings you have made (➔ pages 17 and 18) are ineffective in the DVD 6CH INPUT mode. If you need to change speaker settings, make the settings on the other unit.

1

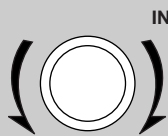

INPUT SELECTOR

DVD / DVD

2

DVD 6CH INPUT



DVD / DVD 6CH

VGCA mode

This unit features a state-of-the-art variable gain control amplifier (VGCA). This feature cuts down greatly on noise encountered during normal use.

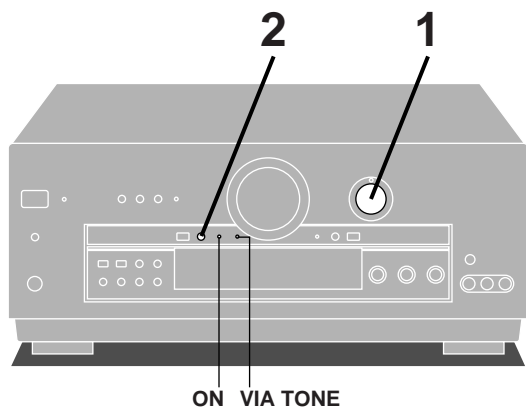

1 Turn [INPUT SELECTOR] to select the source.

2 Press [VGCA].

The "VIA TONE" indicator goes out and the "ON" indicator lights when "VGCA" is selected.

"VGCA ON" is displayed, then "DISPLAY OFF" scrolls across the display. The display then turns off.

If TUNER was chosen as the source, the current frequency is shown.

3 Start the desired source.

Follow your equipment's operating instructions.

To confirm the current display

Press [VGCA].

The display comes on for about 4 seconds.

To turn VGCA off

• When the display is off

① Press [VGCA].

② Press [VGCA] again to turn VGCA off.

• When the display is on

Press [VGCA].

For your reference

You can set the VGCA mode for each source.

Each source will retain the selected mode.

Note

- Tone quality (bass and treble) cannot be adjusted in this mode.
- In STEREO mode, no sound comes from the subwoofer when VGCA is turned on.
- This mode can only be used with analogue input. VGCA is turned off if you select digital input.
- DSP sound modes cannot be selected while VGCA is on. These modes are also canceled when VGCA is turned on and STEREO mode is engaged.

To have the display on constantly

The display is turned off while VGCA is on to cut down on unnecessary noise. Do the following if you would prefer to have the display on.

- ① Turn [INPUT SELECTOR] to select a source other than TUNER.
- ② Press [VGCA] to turn VGCA on.
- ③ After the display turns off Press and hold [VGCA] for about 4 seconds until the display comes on.

This setting remains active even if the unit is turned off.

Repeat the procedure to turn the display off again.

1

INPUT SELECTOR

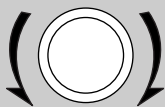

2

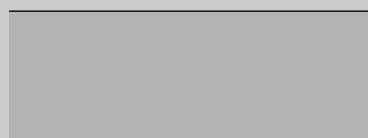
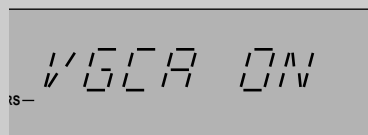

The radio

Sequential tuning

Use the tuning buttons to tune-in radio stations.

- 1 Turn [INPUT SELECTOR] to select “TUNER”.
- 2 Press [BAND] to select “FM” or “AM”.
- 3 Press [TUNING, ∨, ∟, ∟, PTY SELECTOR] (for the United Kingdom) or [TUNING, ∨, ∟, ∟] (for Australia and New Zealand) to tune to the desired frequency.

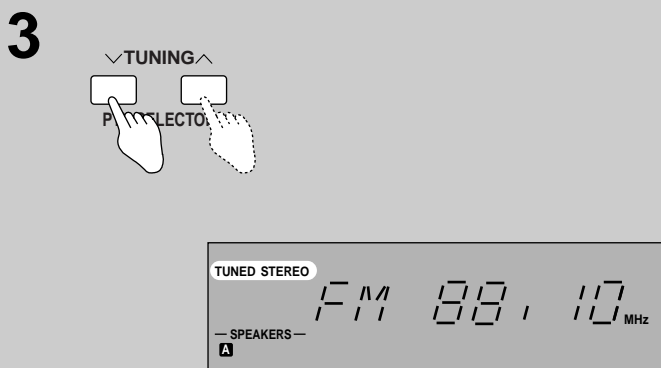
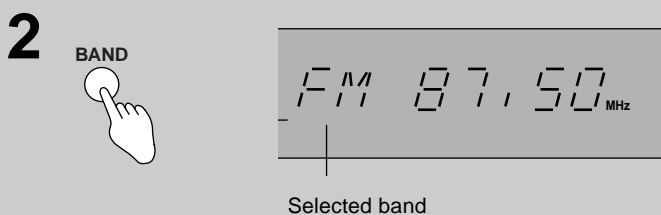
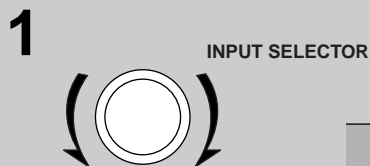
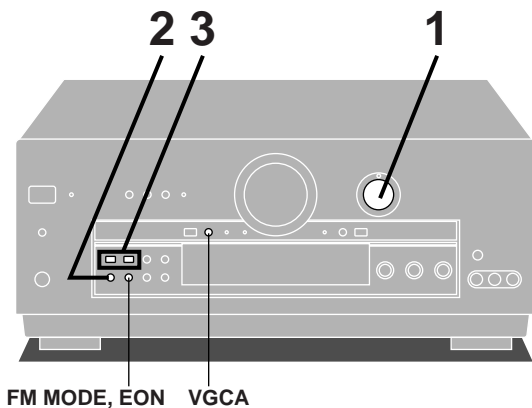

“TUNED” lights up when tuned.

“STEREO” lights up when an FM stereo broadcast is received.

To make an automatic search for stations

Hold down [TUNING, ∨, ∟, ∟, PTY SELECTOR] (for the United Kingdom) or [TUNING, ∨, ∟, ∟] (for Australia and New Zealand) until the frequency begins to scroll. Tuning stops when a station is found. (Tuning may stop if there is interference.)

If noise is excessive in the FM stereo mode

Press [FM MODE, EON] (for the United Kingdom) or [FM MODE] (for Australia and New Zealand).

(“STEREO” will go out, and “MONO” will light up).

The broadcast will be monaural, but noise will be reduced.

If the button is pressed once more, the stereo mode resumes.

If there is hissing or thumping while the radio is playing

Turn VGCA on.

This turns DSP off and can improve sound.

(➔ Page 27 for details about VGCA.)

For your reference

The tuner can pick up interference from DVD players. If this occurs turn the DVD player off.

To change the AM frequency step

Press and hold [BAND] for about 3 seconds when AM band is selected. (The frequency step changes from 9 kHz to 10 kHz.)

To return to the previous step, press and hold [BAND] for about 3 seconds again.

Direct tuning

by remote control only

Specify the frequency using the numbered buttons on the remote control to directly tune to the station.

1 Press [TUNER/BAND].

This will set the remote control to operate the tuner. The selector on the receiver will change to "TUNER". Each time you press the button, the band will change as follows, FM ↔ AM.

2 Press [DIRECT TUNING/DISC ENTER].

3 While cursor display is flashing (approx. 10 seconds) Press the numbered buttons to enter the frequency.

If the desired FM frequency is 107.90 MHz, press 1→0→7→9→0.

If the frequency has been input correctly, the displayed frequency will blink once.

Note

1. If no button is pressed while the cursor display is flashing, the display will return to the frequency which is currently being received. To re-specify the frequency, repeat the procedure from step 2.
2. If the frequency has not been input correctly, "ERROR" will be displayed. In this case, re-enter the frequency.

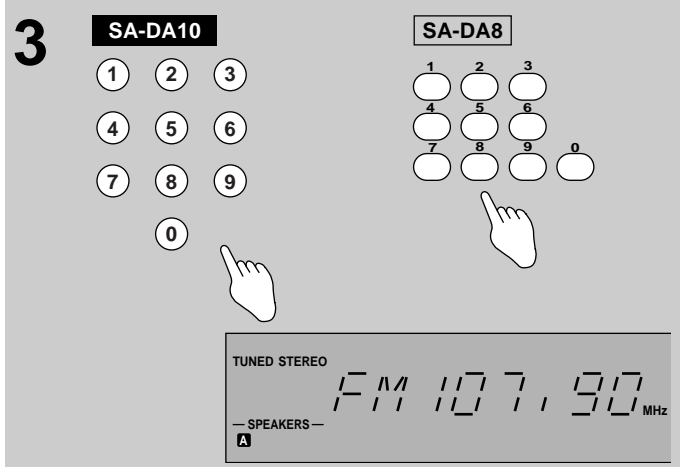
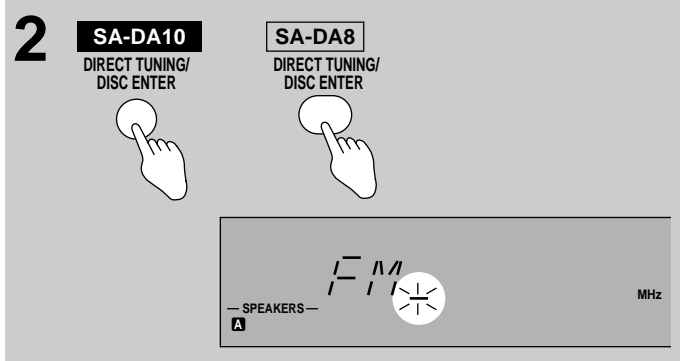
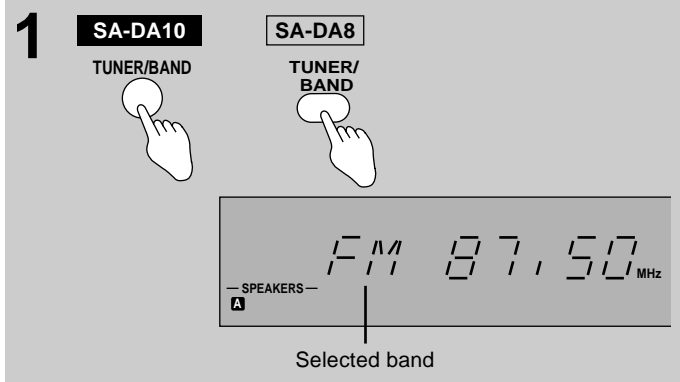
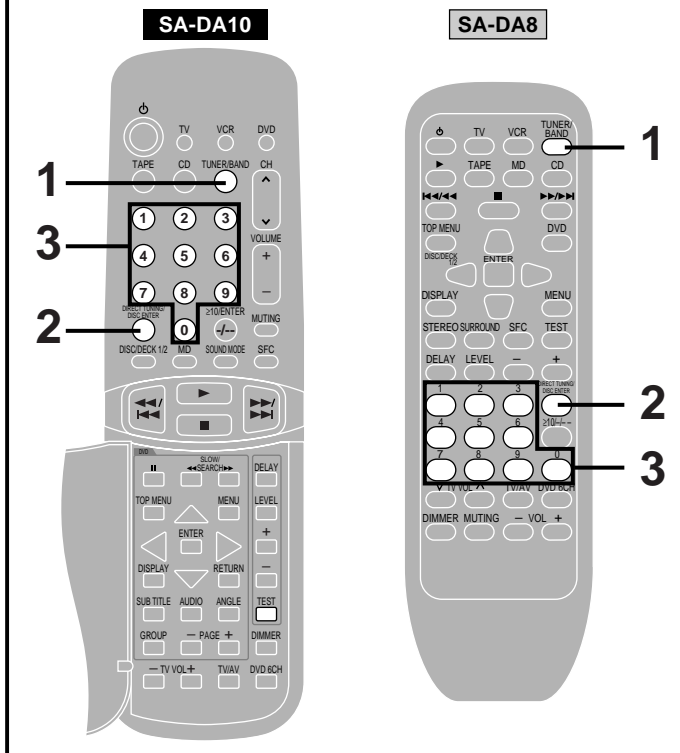

Preset tuning

Presetting radio stations into the memory channels of this unit makes selecting stations simple.

A total of 30 FM and AM stations can be preset.

Please remember this

If a new station is preset into a channel, the setting for the station which was previously entered in that channel will be automatically erased.

Automatic memory presetting

Automatic memory presetting allows this unit to search for stations and then preset them into memory.

1 Tune to the lowest frequency in FM.

(→ Pages 28 and 29.)

2 Press and hold [MEMORY, PTY SEARCH] (for the United Kingdom) or [MEMORY] (for Australia and New Zealand).

Automatic memory presetting will start.

All the FM stations the unit can receive are preset in channels 1 to 30.

3 Tune to the lowest frequency in AM.

(→ Pages 28 and 29.)

4 Press and hold [MEMORY, PTY SEARCH] (for the United Kingdom) or [MEMORY] (for Australia and New Zealand).

Automatic memory presetting will start.

All the AM stations the unit can receive are preset in channels 21 to 30. (Any FM stations in these channels will be replaced.)

During automatic memory presetting, the memory indicator will flash while the frequency scrolls.

When a station is preset

The memory indicator and the preset channel number will be displayed for approximately 1 second. (A)

When presetting is completed

The last station to be preset will be displayed.

Note

Frequencies may not be preset correctly in cases where the broadcast waves are too strong or too weak. In such cases, carry out presetting manually (→ page 31).

2,4

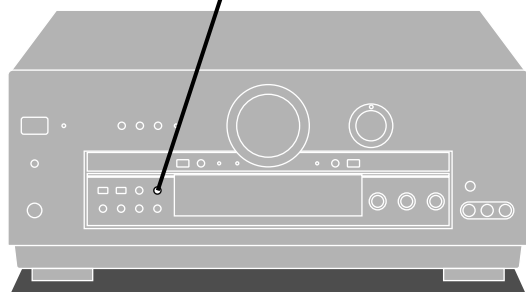

2

MEMORY

PTY SE



4

MEMORY

PTY SE



A

CH 1



The radio

A Manual memory presetting

The desired stations can be preset into the desired channels by the user.

1 Set to the desired frequency.

(→ Pages 28 and 29.)

If interference or static is keeping you from enjoying an FM broadcast, press [FM MODE, EON] (for the United Kingdom) or [FM MODE] (for Australia and New Zealand) and change to monaural. You can preset the station in monaural just as in stereo.

2 Press [MEMORY, PTY SEARCH] (for the United Kingdom) or [MEMORY] (for Australia and New Zealand).

To cancel the memory function, press [MEMORY, PTY SEARCH] (for the United Kingdom) or [MEMORY] (for Australia and New Zealand) again.

3 Press [TUNING, ∨, ∧, PTY SELECTOR] (for the United Kingdom) or [TUNING, ∨, ∧] (for Australia and New Zealand) to select the desired channel.

Holding the buttons down lets you scroll through channels faster.

4 Press [MEMORY, PTY SEARCH] (for the United Kingdom) or [MEMORY] (for Australia and New Zealand).

The channel will blink on the display.

To continue presetting

Repeat steps 1 through 4.

B To listen to preset channels

1 Press [PRESET, DISPLAY MODE] (for the United Kingdom) or [PRESET] (for Australia and New Zealand).

2 Press [TUNING, ∨, ∧, PTY SELECTOR] (for the United Kingdom) or [TUNING, ∨, ∧] (for Australia and New Zealand).

Holding down the buttons lets you scroll through channels faster. The channel number flashes for approximately 5 seconds.

Select the desired channel number during that time.

After 5 seconds, the display will change from the channel number to the frequency.

Note

If you press [PRESET, DISPLAY MODE] (for the United Kingdom) or [PRESET] (for Australia and New Zealand) while the channel number is displayed, the display will change to the frequency.

To confirm the channel number of the station being received

Press [PRESET, DISPLAY MODE] (for the United Kingdom) or [PRESET] (for Australia and New Zealand).

(The channel number flashes for approximately 5 second.)

Note

The channel number is not displayed if you change the frequency or FM mode setting.

For your reference

Even if the AC mains lead is disconnected from the household AC outlet, the memory will retain its contents for approximately one month.

If frequency presettings are accidentally erased

Program the presettings once again.

The AC mains lead should remain connected for one hour or more for the memory back-up to be effective.

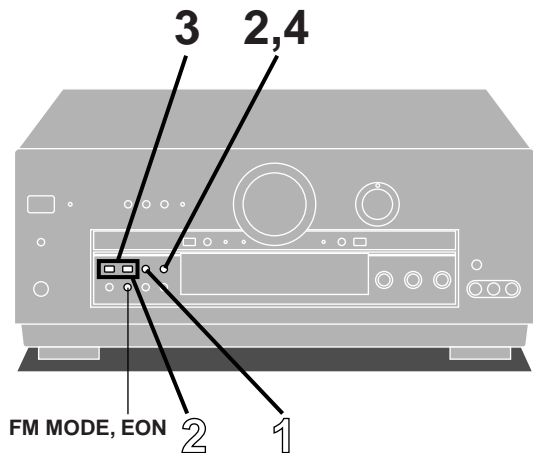

A

2

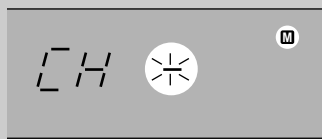
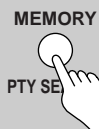

3

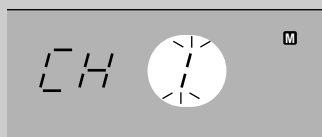

4

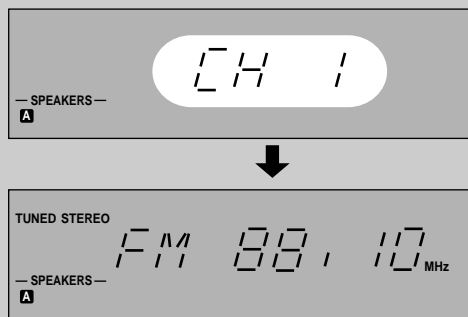
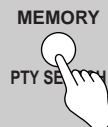

B

1



2

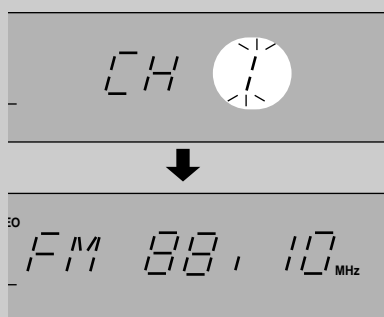
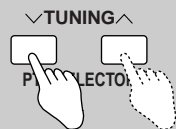

RDS (Radio data system) is a multiplex broadcasting system. Along with the audio signals of FM broadcasts, text information and other signals are transmitted to help you enjoy radio more and make tuning into programs easier. This unit can use the following types of signals.

- **PS** (Program service):
The name of the station can be displayed.
- **PTY** (Program type):
The type of program can be displayed. This signal can also be used to search for a type of program (➔ page 33). See page 35 for more information about the PTY displays.
- **EON** (Enhanced other networks):
This signal is used between networked stations to make it easier for listeners to tune into a type of program (➔ page 34).
- **RT** (Radio text):
This is text transmitted by the station. This unit can show a maximum of 64 characters by scrolling it across the screen. The text could be information about the song playing, traffic and weather reports, phone-in numbers, or police information.

Some areas currently do not have PTY, EON, and RT.

To display RDS information

The display normally shows the radio frequency. When the “RDS” indicator lights, the station is broadcasting RDS signals.

1 Press [RDS].

2 Press [PRESET, DISPLAY MODE].

Each time you press the button, the display changes .

- ① **Frequency display**
- ② **PS display**
(See below if PS is not displayed)
- ③ **PTY display**
(“NO PTY” is displayed if PTY signals are not being received, then the frequency is shown again.)
- ④ **RT display**
(There is no change if RT signals are not being received.)

If RDS signals are not being received, the “RDS” indicator does not light and there is no change when the button is pressed.

For your reference

Occasionally PS isn’t displayed even if PS signals are being received. You may be able to see PS if you change the reception mode.

Press and hold [PRESET, DISPLAY MODE].

The mode switches between “MODE 1” and “MODE 2” every time the button is pressed and held.

If PS isn’t displayed, PS signals are not being received. Restore “MODE 1” in this case.

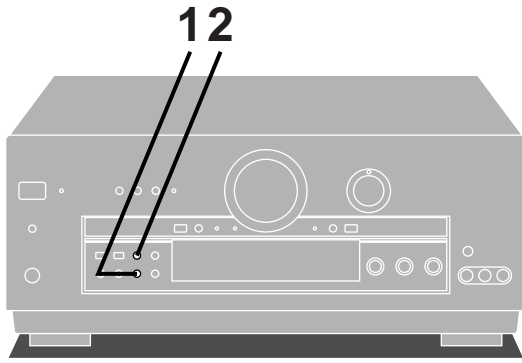

1

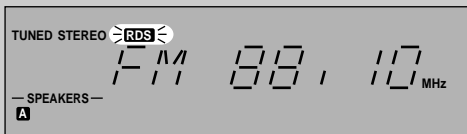

2

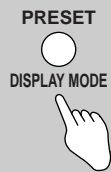

PTY search and EON tuning

Before trying to use these functions, it is necessary to preset radio stations into the receiver's memory (➔ pages 30 and 31). Neither of these functions will work if stations have not been preset.

PTY search

Carry out this operation while listening to an FM broadcast.

PTY search finds a particular type of program for you.

1 Press [RDS].**2 Press [TUNING, ∇, ▲, PTY SELECTOR] to select the desired program type.**

Each time you press the button, the PTY display will change in sequence. (For PTY displays: ➔ page 35.)

3 While the PTY display is flashing (approx. 10 seconds) Press [MEMORY, PTY SEARCH].

"PTY" flashes while the search is carried out.

When the selected type of program is located

The receiver automatically switches over to the station broadcasting the program. The PTY indicator continues to flash for about two seconds after the program is found. During this time the display changes, first showing the preset channel number, then the frequency of the station, and finally the previously selected display mode is resumed.

Restarting a search

It is possible to restart the search during the two seconds that the PTY indicator is flashing after the program is found, simply by pressing [MEMORY, PTY SEARCH] again.

It is also possible to search for the same kind of program on another station by pressing [MEMORY, PTY SEARCH] at any time if the display is in PTY mode. If [MEMORY, PTY SEARCH] is pressed in any other display mode, the message "SELECT PTY FIRST" scrolls across the display.

If the desired type of program is not found

"NO PTY" will be displayed for a moment, then the current frequency and the receiver will return to the original display.

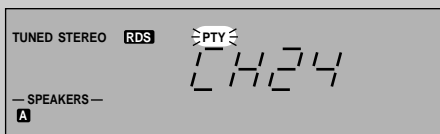
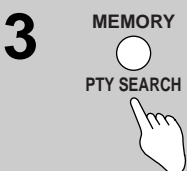
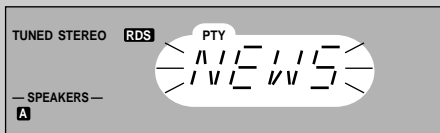
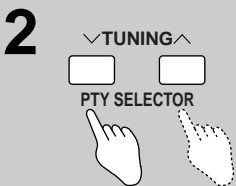
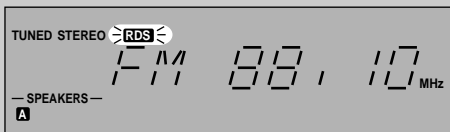
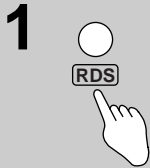
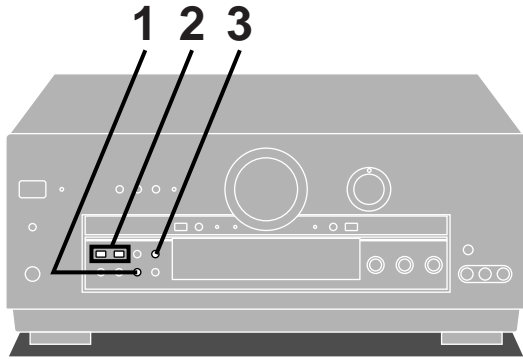

EON tuning

EON tuning is useful if the type of program you want to listen is not currently being broadcast. It allows you to set the unit to automatically change to a particular type of program when one begins.

EON tuning only works if RDS data and EON signals are being received.

EON tuning finds programs on stations that share EON signals.

- 1 Press [RDS].**
- 2 Press [TUNING, ∇, ▲, PTY SELECTOR] to select the desired program type.**

Each time you press the selector, the PTY display will change in sequence. (For PTY displays: ➔ page 35.)

- 3 While the PTY display is flashing (approx. 10 seconds) Press [FM MODE, EON].**

“EON” will light up.

The current station remains tuned in until the selected type of program begins. When the receiver finds the type of program you selected, “EON” appears on the display and the message “OTHER PROGRAM SERVICE” scrolls from right to left across the display. The receiver automatically changes over at this time. If the type of program you selected is currently broadcasting, the receiver will immediately change to that station.

Note

EON tuning turns OFF if you operate the tuner (➔ pages 28–31), change the input source, or turn the unit OFF.

When “NO EON” is displayed

The broadcast you are presently receiving does not provide EON service.

To check the program type while on reception standby

Press [TUNING, ∇, ▲, PTY SELECTOR].

The program type last selected will be displayed for approximately 2 seconds. (“EON” will flash.)

Note

If you press [TUNING, ∇, ▲, PTY SELECTOR] again while the program type is being displayed, you will turn EON tuning OFF.

To cancel EON tuning

Press [FM MODE, EON].

“EON” will go out.

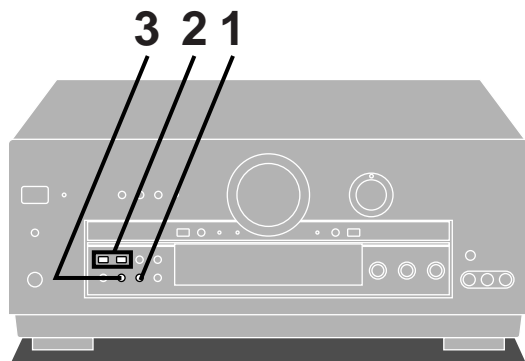

1

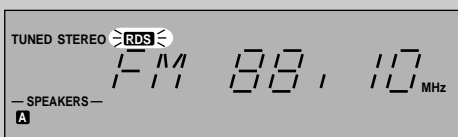

2

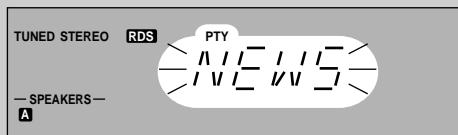
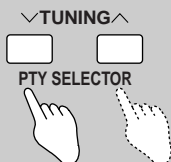

3

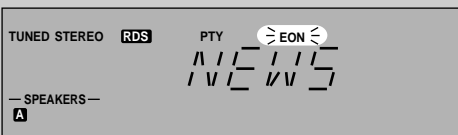

About the PTY display

There are a total of 31 PTY displays on this unit. The display changes each time [TUNING, ∇ , \wedge , PTY SELECTOR] is pressed.

The table below shows the order in which the display changes, and also gives an explanation of each display.

Display	Explanation
NEWS	News
AFFAIRS	Current affairs
INFO	Information
SPORT	Sport
EDUCATE	Education
DRAMA	Drama
CULTURE	Culture
SCIENCE	Science
VARIED	Varied
POP M	Pop music
ROCK M	Rock music
M. O. R. M	Middle-of-the-road Music
LIGHT M	Light classical
CLASSICS	Serious classical
OTHER M	Other music
WEATHER	Weather information
FINANCE	Finance
CHILDREN	Children
SOCIAL A	Social affairs
RELIGION	Religion
PHONE IN	Phone in
TRAVEL	Travel
LEISURE	Leisure
JAZZ	Jazz music
COUNTRY	Country music
NATIONAL	National music
OLDIES	Oldies
FOLK M	Folk music
DOCUMENT	Documentary
TEST	Test broadcast
ALARM	Emergency announcement

Note

This unit does not have EBS-Emergency Broadcast System which tunes automatically into emergency broadcasts when they begin.

Other functions

A To listen through headphones

- 1 Reduce the volume.
- 2 Connect the headphones.
Plug type: 6.3 mm stereo
- 3 Adjust the volume.

Select STEREO or turn both SPEAKERS A and B, or BI-WIRE off when using headphones. Turning the speakers off automatically engages STEREO mode and ensures no sound is heard from the subwoofer. If SURROUND is used, the sound heard through the headphones will seem unusual.

Note

Avoid listening for prolonged periods of time to prevent hearing damage.

B Dynamic range compression

“Dynamic range compression” (DR COMP) is a function for compressing the dynamic range (reproduction level range) of audio signals. It is used for viewing movie software late at night or at other times when high volume levels are not desirable.

This function only works with DR COMP compatible Dolby Digital format software.

OFF: The dynamic range is not compressed.

STANDARD: The dynamic range is compressed according to a level set by the producer of the software.

MAX: The dynamic range is compressed to the maximum permitted level.

The factory setting is “OFF”.

- 1 Press [A] and [B] at the same time.

“SETTING” appears on the display.

- 2 Press [A] to select “DR COMP”.

Each time you press the button, the display switches as follows.

SIZE → DISTANCE → FILTER → DR COMP

- 3 Turn [INPUT SELECTOR] to select the setting.

Each time you turn the selector, the display switches as follows.

OFF ↔ STANDARD ↔ MAX

- 4 Press [A] and [B] at the same time.

“COMPLETE” appears on the display.

For your reference

When DR COMP is on, scenes that already have a low sound level will be heard as they are. When scenes that are loud occur, the function acts to reduce the peak level.

The sound field will remain intact even if DR COMP is functioning.

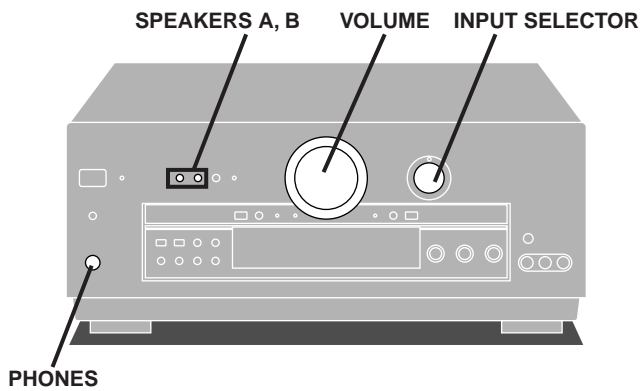

A

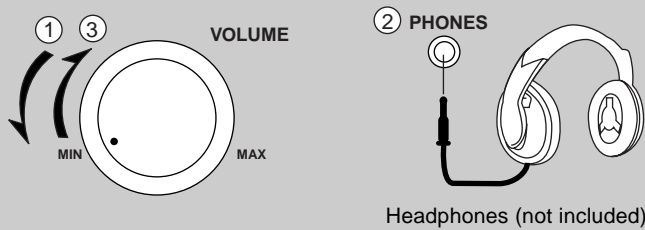

B

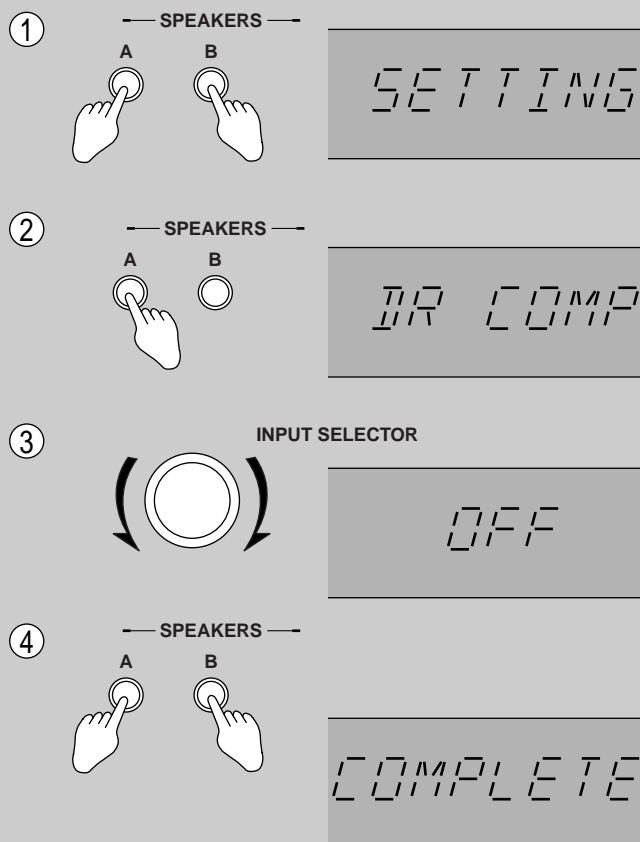

A To mute the sound level

by remote control only

Press **[MUTING]**.

The message "MUTING ON NOW" runs repeatedly from right to left across the display as long as the muting function is on.

Press once again to return to the previous volume level.

Note

Muting is canceled when the receiver is turned off.

B When using the unit in a darkened room

by remote control only

Dimming the display and turning off the white lights (SA-DA10 only) can improve video viewing in dark or dimly lit rooms.

Press **[DIMMER]**.

Repeat to turn on again.

Note

The display and white lights return to normal when the unit is turned on.

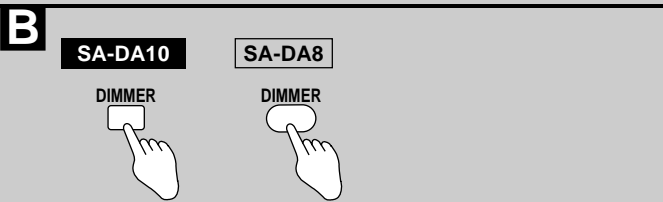
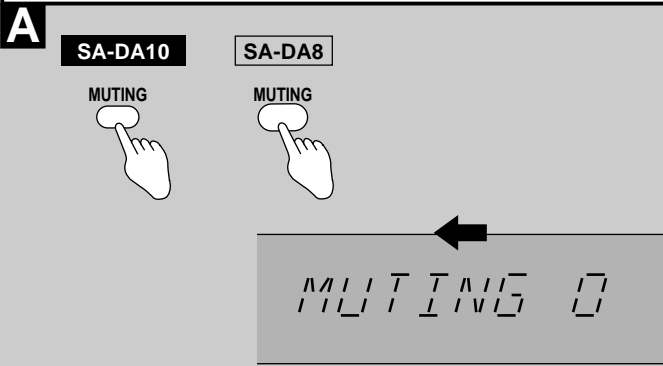
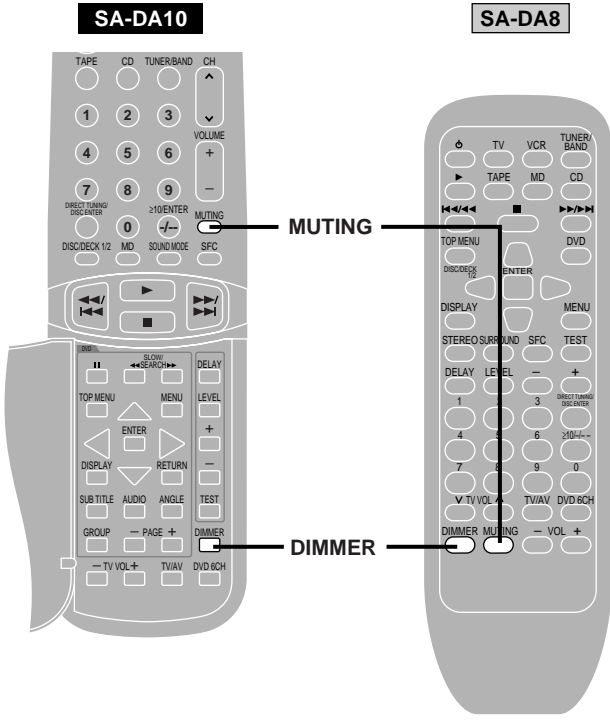

The remote control

SA-DA10

SA-DA8

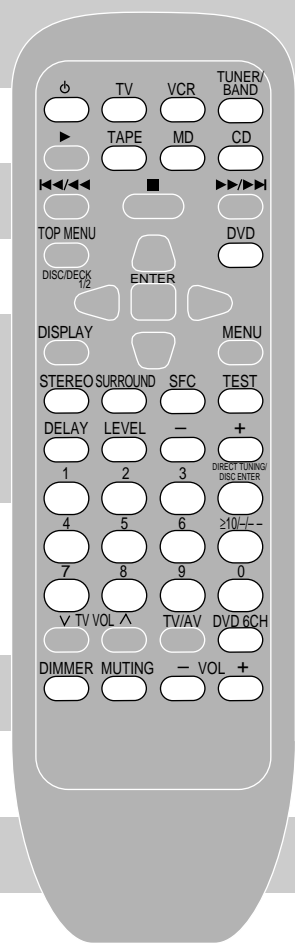
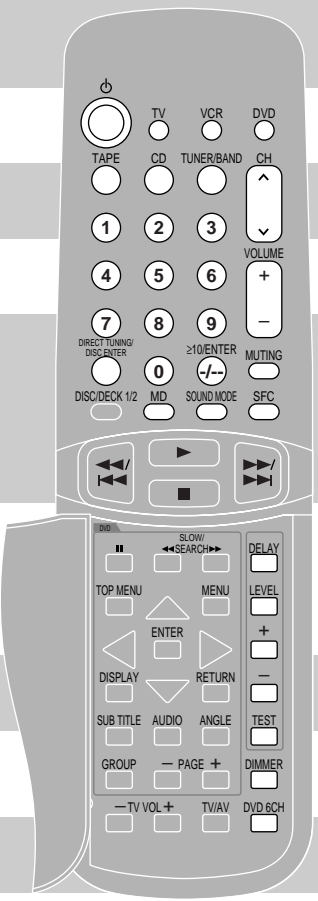
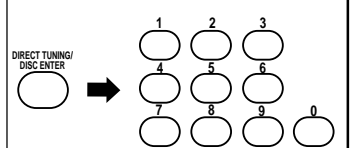
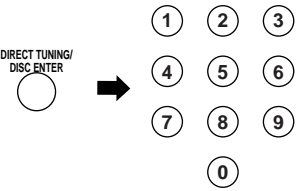
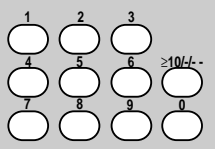
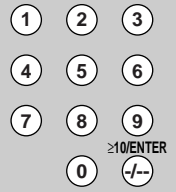
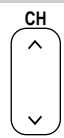
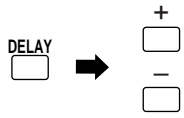
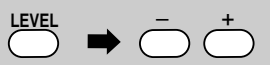
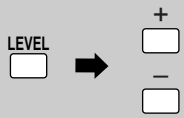
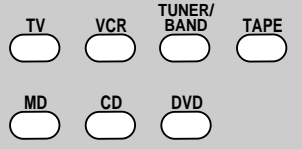
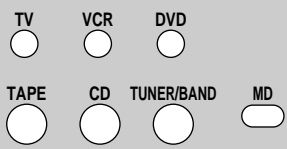

To operate the receiver	
To switch between on and standby	
To select an input source (except PHONO and VCR 2/ FRT-VCR 3) and switch the remote control to each operation mode	<p>Note</p> <ul style="list-style-type: none"> • TAPE MONITOR cannot be controlled with the [TAPE] button. • The remote control for Australia and New Zealand does not have an [MD] button.
To select DVD 6CH INPUT mode	(→ Page 26)
To adjust the volume	
To select the DSP sound modes	(→ Page 22)
To turn SFC on and select the mode	(→ Page 23)
To output a test signal	(→ Page 19)
To select the speaker channel and adjust its output level	<ul style="list-style-type: none"> • When the SURROUND or SFC modes are on (→ Pages 19 and 23) You can adjust the level of the center and surround speakers and the subwoofer. • When the STEREO mode is on You can adjust the level of the subwoofer.
When an SFC mode is on To change the surround channel delay time	(→ Page 23)
To mute the sound level	(→ Page 37)
To dim the display	(→ Page 37)
To select "FM" or AM"	(→ Page 29)
To select the desired channel sequentially (Preset tuning)	
To select the desired channel directly (Preset tuning)	<div style="display: flex; justify-content: space-around; align-items: flex-start;"> <div style="text-align: center;"> <p>(Example: Channel 1)</p> <p>①</p> </div> <div style="text-align: center;"> <p>(Example: Channel 10)</p> <p>≥10/ENTER</p> <p>within 10 seconds</p> </div> </div>
To select radio stations by frequency (Direct tuning)	(→ Page 29)

SA-DA10

SA-DA8

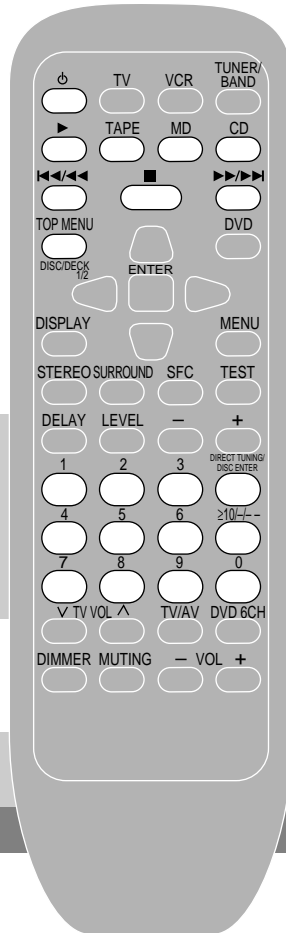
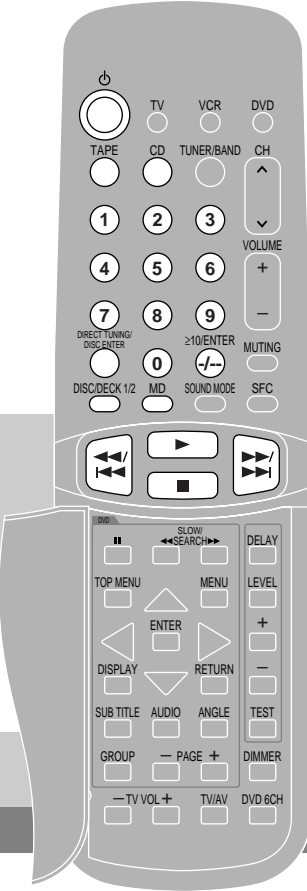
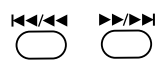
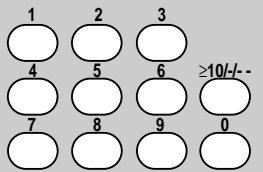
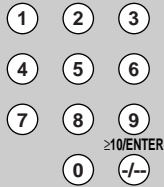
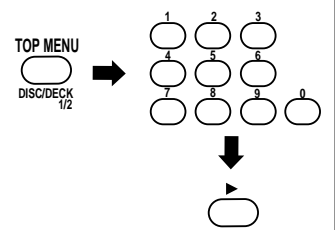
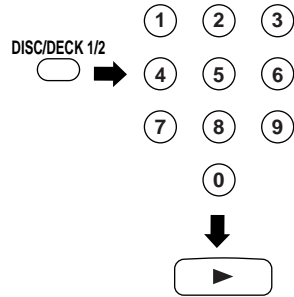
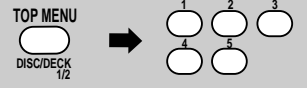
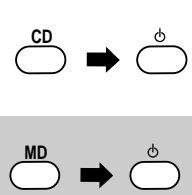
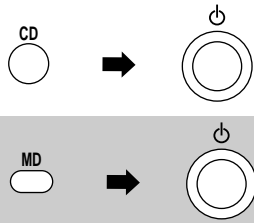

To operate a CD player or MD deck

To turn the CD player ON/OFF

To turn the MD deck ON/OFF

Only for the United Kingdom

Note

The remote control for Australia and New Zealand does not have an [MD] button.

To start play

[5 CD changer only]

To start play from the desired disc

[MEGA CD changer only]

To start play from the desired disc

"MEGA CD changer" means any Technics CD changer that takes more than 50 discs.

(When selecting discs, [≥ 10 /ENTER, -/--] (SA-DA10) or [≥ 10 /-/--] (SA-DA8) does not respond to touch.)

For your reference

If you press this button instead of [▶] shown in the above procedure, the CD changer will stop and display the disc number. To start the disc, press [▶].

To start play from the desired track

(Example: Track 1)



(Example: Track 10)

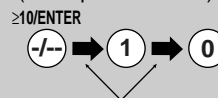

within 10 seconds

To skip a track

To stop play

To operate a cassette deck

To turn the cassette deck ON/OFF

Only when using a double cassette deck

To select the tape deck (DECK 1/DECK 2)

To start play

While the tape is stopped

To fast-forward or rewind the tape

With TPS-equipped cassette decks, you can move to the beginning or end of a track by pressing these buttons while the tape is playing.

To stop play

SA-DA10

SA-DA8

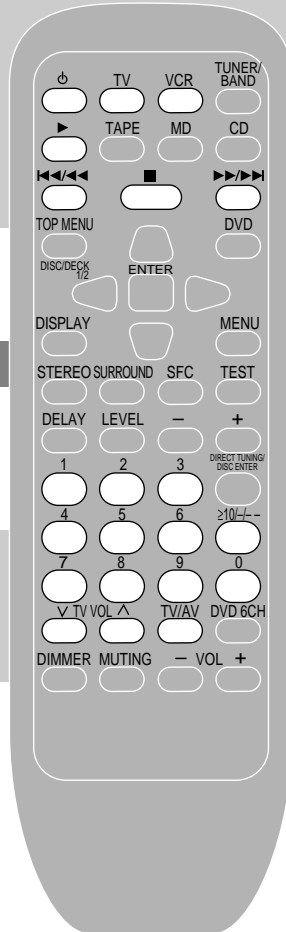
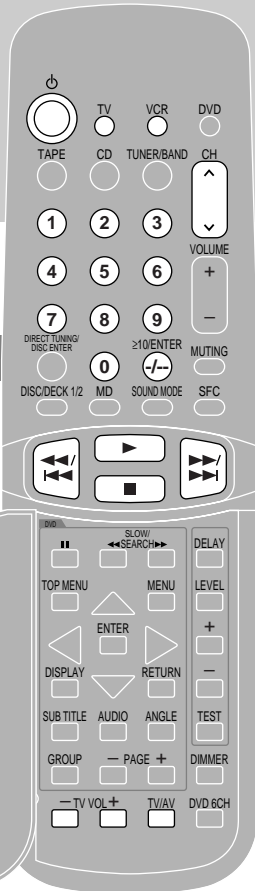
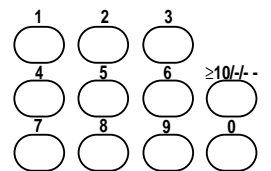
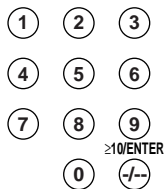
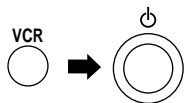
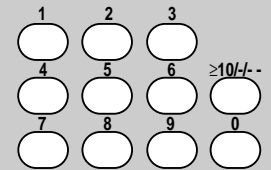
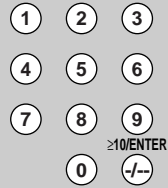
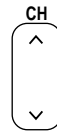
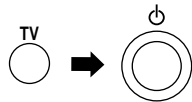

SA-DA10

SA-DA8

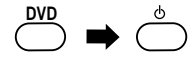
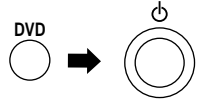

TOP MENU



TOP MENU



MENU



DISPLAY



DISPLAY

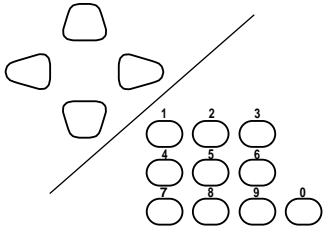
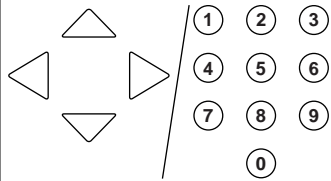

ENTER



RETURN



SUB TITLE



AUDIO



ANGLE

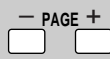
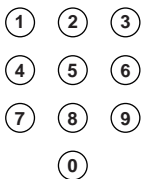
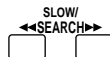
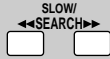

GROUP

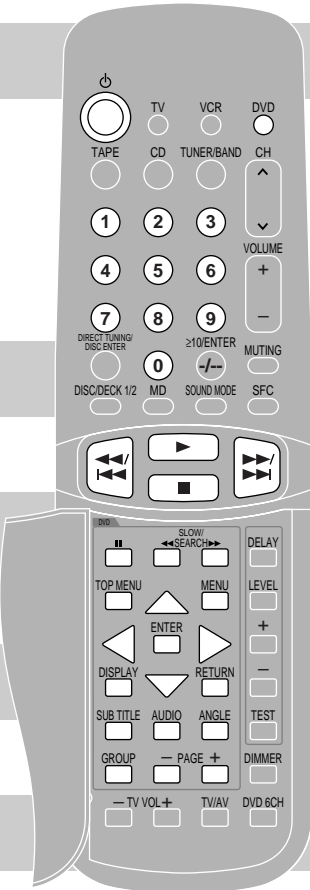
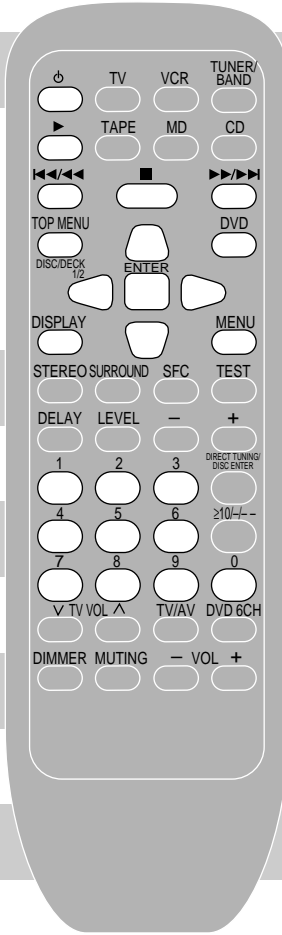

To operate a DVD player	
To turn the DVD player ON/OFF	
To start play	
To skip to the beginning of a track or chapter	
To display the top menu	
To display the menu	
To display the GUI menu icons	GUI—graphic user interface. See your player's manual for details.
To select items	Press to select items after you press [TOP MENU], [MENU], [DISPLAY], [SUB TITLE], [AUDIO] or [ANGLE].
To enter the selected items	
To clear the GUI display	
To display the subtitle icon	
To display the soundtrack icon	
To display the angle icon	
To pause play	
To search through the disc	
While paused To start slow-motion play	
While paused To view frame-by-frame	
To start play from a selected track or chapter	
[DVD Audio only] To select still pictures – Page skip	
[DVD Audio only] To select a group	
To stop play	

SA-DA10 only

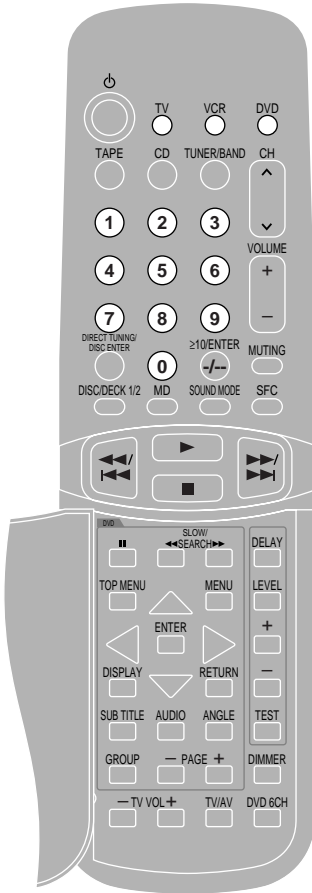

TV VCR DVD

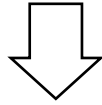

① ② ③
④ ⑤ ⑥
⑦ ⑧ ⑨
⑩

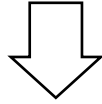

① ② ③
④ ⑤ ⑥
⑦ ⑧ ⑨
⑩

To change the remote control code

Hold down the button corresponding to the component you wish to operate.

Continue to hold the button down and...

Aim the remote control at the component you wish to operate and carefully and slowly press the numbered buttons to enter the appropriate two-digit code number.

(Refer to the tables on the facing page for the code numbers.)

When the two-digit code number is entered, the remote control will automatically output the on/off signal.

If you changed the code correctly, the component switches on or off.

Change the remote control code in either of the following circumstances:

- If the Panasonic TV, VCR or DVD player does not operate as a result of a difference in the remote control code.
- If you wish to operate some other make of TV, VCR or DVD player.
(➡ Refer to pages 42–45 for the buttons which can be used.)

Note

- Even after changing the code there may be cases where certain operations cannot be done or operation is not possible at all.
- Changes to the codes are canceled when the remote control's batteries are replaced. Reenter the code.

TV codes

PANASONIC	01, 29, 30, 31	INNO HIT	34	SALORA	07, 37
AKAI	07, 11, 28, 36, 37	ITT/NOKIA	05, 07, 37	SAMSUNG	11, 12, 15, 21, 25, 34, 39
ALBA	05, 11, 12	JVC	18	SANYO	07, 17, 25, 37
BAUR	32	KENDO	40	SCHNEIDER	11, 12
BLAUPUNKT	28, 36	LOEWE	14, 33	SEG	39, 40
BRANDT	26, 41	LOEWE OPTA	32	SELECO	11, 24
BUSH	02, 05, 10, 11, 12, 32, 38	LUXOR	37	SHARP	17, 20
DAEWOO	11, 12, 32	MATSUI	02, 05, 06, 07, 10, 11, 12, 25, 37, 38	SIEMENS	11, 12, 17, 28, 36
DUAL	32	mitsubishi	14, 19, 28, 36	SINUDYNE	02, 05, 11, 12, 22, 24, 38, 40
FERGUSON	11, 12	NOKIA	05, 07, 37	SONY	16
FINLUX	11, 12, 22, 23, 24, 25, 40	NORDMENDE	26, 41	THOMSON	05, 26, 41
FISHER	37	OCEANIC	27, 35	THORN	06, 08, 11, 12, 14, 16, 25, 32
FUNAI	02, 38	ORION	02, 03, 05, 10, 11, 12, 38	TOSHIBA	03, 04, 06, 08
GOLDSTAR	11, 12	PHILIPS	11, 12, 13, 15	UNIVERSUM	39
GOODMANS	11, 12, 25, 32	PHONOLA	11, 12	WHITE WESTIN HOUSE	11, 12, 22, 40
GRUNDIG	28, 36	RADIOLA	11, 12		
HITACHI	01, 09, 26, 41	ROADSTAR	39		
ICE	21, 39	SABA	26, 41		

VCR codes

PANASONIC	01, 29, 30	JVC	20, 21	ROADSTAR	02, 03, 18, 23, 27
AKAI	06, 08, 16, 17, 19, 37	KENDO	08, 09, 37	SABA	21
ALBA	02, 06, 23	LOEWE	03, 32	SALORA	08, 11, 17, 19, 37
BAIRD	08, 10, 37	LUXOR	08, 10, 11, 17, 19, 37	SAMSUNG	15, 16, 18, 27
BLAUPUNKT	01, 26, 29, 30, 33	MATSUI	03, 05, 09	SANYO	07, 10, 11
BUSH	02, 09, 23	METZ	01	SCHAUB LORENZ	10
DAEWOO	15	mitsubishi	17, 19, 21, 32	SCHNEIDER	02, 03, 18, 23, 27, 32
FERGUSON	31	NEC	04, 21, 36, 37	SEG	02, 18, 23, 27
FISHER	05, 07, 10, 11, 12	NOKIA	08, 10, 11, 18, 22, 27, 37	SHARP	22
GOLDSTAR/LG	03, 04, 36, 37			SIEMENS	03, 10, 11, 32
GOODMANS	02, 03, 18, 23, 27, 33	NORDMENDE	20, 21	SONY	24, 25, 26
GRUNDIG	02, 23, 26, 28, 32, 33	OKANO	06	THOMSON	21
HCM	02, 23	ORION	05, 09	THORN	10
HITACHI	13, 14	PHILIPS	22, 32, 33, 34, 35	TOSHIBA	15, 17, 19, 32
ITT	08, 10, 11, 37	PHONOLA	32	UNIVERSUM	03, 08, 32, 37
ITT/NOKIA	18, 27, 37	RFT	33		

DVD player codes

PANASONIC	01	PHILIPS	04, 16	SONY	05
DENON	01, 17	PIONEER	03	TECHNICS	01
FERGUSON	02	RAITE	13	THOMSON	02
HITACHI	11	RCA	02	TOSHIBA	04
JVC	09	SABA	02	YAMAHA	01
KENWOOD	15	SAMPO	14	ZENITH	07, 12
MITSUBISHI	06	SAMSUNG	10		
NORDMENDE	02	SHARP	08		

Making a recording

Note

- You cannot record a source connected through a digital terminal.
- When recording CD, DVD, or TV, ensure the source is connected through the corresponding analogue terminals (➔ pages 10–12) and “ANALOG” input is selected (➔ page 22).
- When you select DVD 6CH INPUT mode, only sound from the front left and right channels is recorded.

A Recording on a tape deck or VCR

You can record to a tape deck connected to TAPE REC (OUT) or to a VCR connected to VCR 1 OUT.

See the recording unit's operating instructions for details on how to prepare it for recording.

When recording with a tape deck, you can record any source except TAPE.

When recording with a VCR, you can record any source except TAPE or VCR 1.

Note

Recording from the tape deck to the VCR is not possible.

1 Turn [INPUT SELECTOR] to select the source to be recorded.

2 If you selected VCR 2 in step 1, set [VCR 2, VCR 3] to the required position.

3 Begin recording.

Follow your recording unit's operating instructions.

4 Begin the source to be recorded.

Follow your equipment's operating instructions.

B To monitor sound being recorded onto a tape deck

It is possible to check the sound being recorded if your tape deck is a 3 head system.

Press [TAPE MONITOR] on this unit and set the monitor button on the tape deck to “TAPE”.

Press [TAPE MONITOR] once again to turn it off.

For your reference

Use the VCR 3 terminals on the front of the unit when dubbing from a video camera.

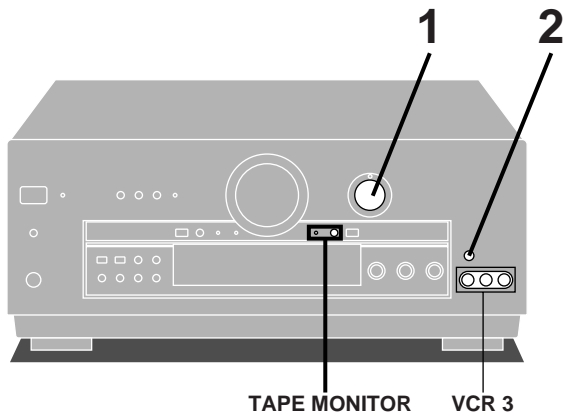

A

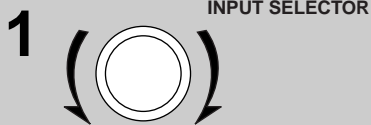

2

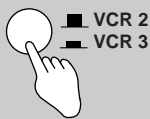

B

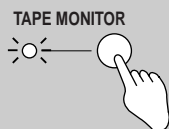

Timer function

There are two timer functions: the sleep timer and the wake timer.

- **Sleep timer:**

The unit turns off after a set time.
It can be set for 30, 60, or 90 minutes.

- **Wake timer:**

The unit can be set to turn on a certain number of hours after it is turned off.
It can be set for 5, 7, or 9 hours.

Setting the timers

1 Press [TIMER, -MODE, -TIME] to select the desired timer mode.

Each time you press the button, the timer mode changes.

2 [Within 5 seconds] Press [TIMER, -MODE, -TIME] and release when the time you require is displayed.

The display changes as follows:

- **In sleep timer mode**

30 → 60 → 90 (minutes)



- **In wake timer mode**

5H → 7H → 9H (hours)



The display is restored 5 seconds after the setting is completed.

3 **Wake timer mode only** Press [⏻/⏻] to turn off the unit.

The "WAKE" indicator lights up.

Checking the remaining time on the sleep timer and the time set for the wake timer

Press [TIMER, -MODE, -TIME] once.

Note

Do not press [TIMER, -MODE, -TIME] again before the remaining time indication goes out.
The setting may change if you do this.

Changing a setting

Repeat steps 1 and 2.

To cancel the timer

Press [TIMER, -MODE, -TIME] until "OFF" is displayed.
"SLEEP" or "WAKE" will go out.

Note

- The timers cannot be used together.
- The sleep timer turns off the receiver, and the wake timer turns on the receiver, but they do not turn off/on any externally connected components.

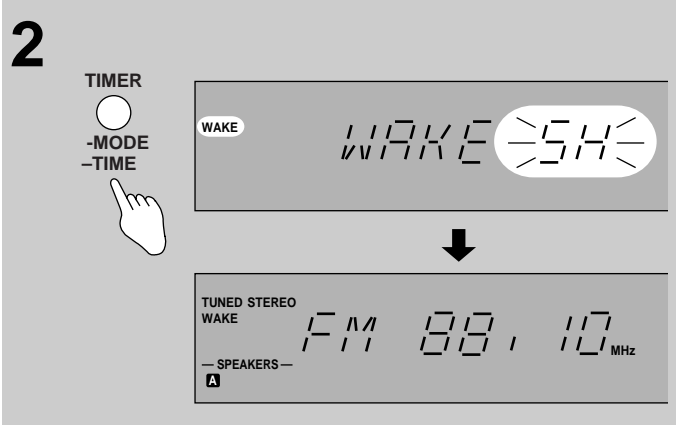
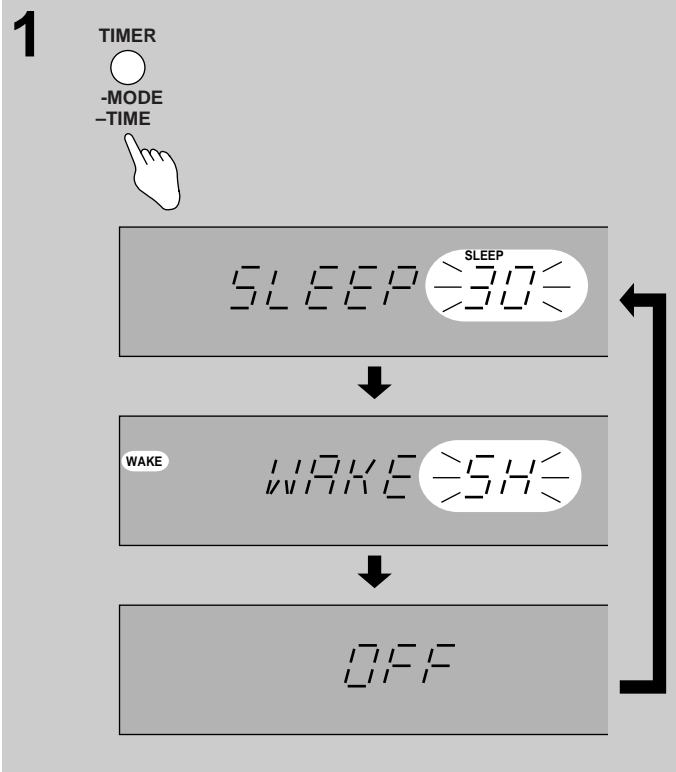
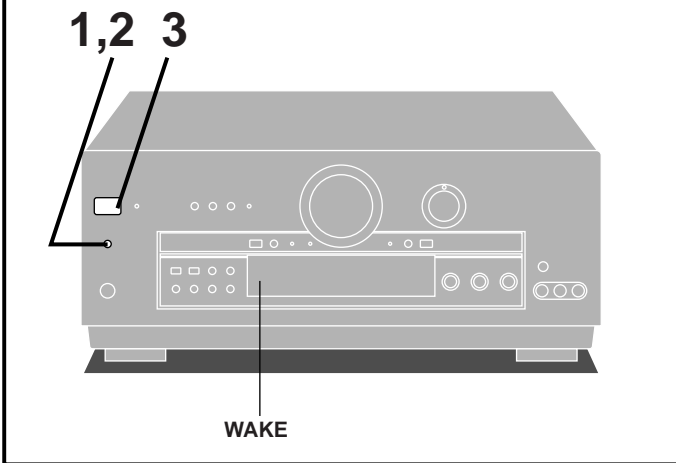

Troubleshooting guide

Before requesting service for this unit, check the chart below for a possible cause of the problem you are experiencing. Some simple checks or a minor adjustment on your part may eliminate the problem and restore proper operation.

If you are in doubt about some of the check points, or if the remedies indicated in the chart do not solve the problem, refer to the directory of Authorized Service Centers (enclosed with this unit) to locate a convenient service center, or consult your dealer for instructions.

Problem	Probable cause(s)	Suggested remedy	Page(s)
While listening to FM broadcasts			
Hiss is heard during stereo broadcasts, but not during monaural ones.	Modulation for the two types is different so some noise may be heard during stereo broadcasts.	<ul style="list-style-type: none"> ● Reduce the treble. ● Change the location and direction of the antenna. ● Use an outdoor antenna. ● Use an antenna with more elements. 	25 12, 13
	Antenna location and direction poor.		13 –
Excessive noise in both stereo and monaural broadcasts.	Station is distant.	<ul style="list-style-type: none"> ● Select "VGCA ON". 	27
	Antenna location and direction poor.	<ul style="list-style-type: none"> ● Change the location and direction of the antenna. ● Use an outdoor antenna. ● Use an antenna with more elements. 	12, 13
"STEREO" and "TUNED" indicators flicker.	Station is distant.		13 –
	Building or mountain nearby.		
Stereo broadcasts highly distorted.			

While listening to AM broadcasts			
Unusual "beat" sound is heard.	A television is on nearby.	<ul style="list-style-type: none"> ● Separate the two or turn the television off. 	–
	Adjacent signal is interfering.	<ul style="list-style-type: none"> ● Reduce the treble. 	25
		<ul style="list-style-type: none"> ● Select "VGCA ON". 	27
Low-pitched "hum" is heard when a station is tuned.	AC mains lead is near the antenna wires.	<ul style="list-style-type: none"> ● Separate the AC mains lead from the wires. 	–
	Electronic interference from the AC mains lead is fed to the speakers.	<ul style="list-style-type: none"> ● Use an outdoor antenna. 	13
A continuous or intermittent hiss is heard.	Interference from other appliances.	<ul style="list-style-type: none"> ● Separate this unit from such appliances. 	–
An AM broadcast station cannot be picked up clearly.	Frequency step is set to 10 kHz.	<ul style="list-style-type: none"> ● Hold down [BAND] for about 3 seconds. This changes the frequency step to 9 kHz. 	28

While enjoying the surround sounds			
Sound is not heard from the center, surround or subwoofer speakers.	The presence setting of the speaker has been incorrectly set to "NONE" or "NO".	<ul style="list-style-type: none"> ● Set the type and presence setting of each speaker correctly. 	17, 18
	The DSP sound mode has been incorrectly set to "STEREO".	<ul style="list-style-type: none"> ● Set to SURROUND mode. 	22
SURROUND and SFC cannot be selected.	VGCA is ON.	<ul style="list-style-type: none"> ● Select "VGCA OFF". 	27
	SPEAKERS B is on.	<ul style="list-style-type: none"> ● Turn SPEAKERS B off. 	22
Cannot play Dolby Digital or DTS sources.	The PCM FIX mode may be on.	<ul style="list-style-type: none"> ● Turn PCM FIX mode off. 	21
	The DTS FIX mode may be on.	<ul style="list-style-type: none"> ● Turn DTS FIX mode off. 	21
	An SFC mode is on.	<ul style="list-style-type: none"> ● Switch to SURROUND or STEREO mode. 	20

Problem	Probable cause(s)	Suggested remedy	Page(s)
Common Problems			
Unit doesn't come on.	The AC mains lead plug is not fully inserted.	<ul style="list-style-type: none"> Confirm the plug is fully inserted. 	–
Sound is not heard.	The speaker indicators are off.	<ul style="list-style-type: none"> Turn on the speaker indicators. 	22
	The tape monitor function is on.	<ul style="list-style-type: none"> Press the tape monitor button. 	24
	The muting function is on.	<ul style="list-style-type: none"> Press the muting button on the remote control. 	37
	Incomplete or incorrect connection to speakers and external equipment.	<ul style="list-style-type: none"> Check all connections. 	10–16
	The incorrect input source has been selected.	<ul style="list-style-type: none"> Select the correct source. 	22
	Digital signals this unit cannot decode are being played.	<ul style="list-style-type: none"> Either have the player convert the signals so this unit can handle them or switch to ANALOG input. 	22, 23
Cannot play CD, DVD, or TV.	The DIGITAL input mode is set to DIGITAL or ANALOG.	<ul style="list-style-type: none"> Change the setting to suit the type of connection you have made. 	22
Nothing appears on the display.	VGCA is ON.	<ul style="list-style-type: none"> Nothing appears on the display while VGCA is on. To turn the display on, press and hold [VGCA]. 	27
The display is dim.	The dimmer is on.	<ul style="list-style-type: none"> Press [DIMMER] to restore the display to normal. 	37
The picture doesn't appear on the television.	Connection is incorrect.	<ul style="list-style-type: none"> Check and correct connections. 	10, 11
	The television's input mode is incorrect.	<ul style="list-style-type: none"> Change the input mode to suit the connections between this unit and the television. 	–
Sound suddenly stops or none is heard when the unit is switched on. "OVERLOAD" appears on the display.	The protection circuitry has functioned because: the positive and negative speaker wires have shorted; speakers with a lower impedance than this unit's rated impedance are being used; the speakers are under strain through excessive volume, excessive power, or by being used in a high temperature environment.	<ul style="list-style-type: none"> Switch off the unit, determine and correct the cause, then switch the unit on. Use speakers with the right impedance rating. 	– 14–16
"F70" appears on the display.		<ul style="list-style-type: none"> Turn off the unit and then turn it on again, or disconnect the AC mains lead and then connect it to your household mains socket again. (If "F70" remains on the display, consult an authorized service center or your dealer.) 	–

The RESET function

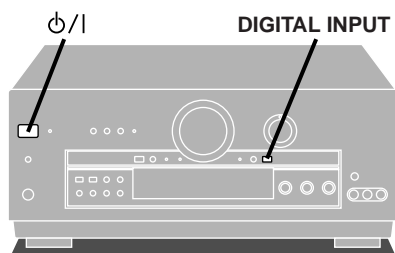

While the unit is on

While pressing and holding [DIGITAL INPUT], press and hold [power/I] until "RESET" appears on the display.

The operation settings for the unit will be initialized to the settings made at the time of shipment.

However, any preset radio stations will not be erased.

Maintenance

If the surfaces are dirty

To clean this unit, wipe with a soft, dry cloth.

If the surfaces are extremely dirty, use a soft cloth dipped in a soap-and-water solution or a weak detergent solution.

- Never use alcohol, paint thinner or benzene to clean this unit.
- Before using chemically treated cloth, read the instructions that came with the cloth carefully.

Specifications (DIN 45 500)

■ AMPLIFIER SECTION

Power output (at 240 V)	
DIN 1 kHz (T.H.D. 1 %)	2 x 100 W (6 Ω)
20 Hz–20 kHz continuous power output both channels driven	2 x 80 W (6 Ω)
Total harmonic distortion	
rated power at 20 Hz–20 kHz	0.09 % (6 Ω)
half power at 1 kHz	0.03 % (6 Ω)
Power output at the DVD 6CH operation	
DIN 1 kHz (T.H.D. 1 %)	
Front	2 x 100 W (6 Ω)
Center	100 W (6 Ω)
Surround	2 x 100 W (6 Ω)
Power bandwidth	
both channels driven, –3 dB	10 Hz–70 kHz (6 Ω, 0.9 %)
Damping factor	30 (6 Ω)
Load impedance	
Front	
A or B	4–16 Ω
A and B	8–16 Ω
BI-WIRE	6–16 Ω
Center	6–16 Ω
Surround	6–16 Ω
Frequency response	
PHONO RIAA standard curve (30 Hz–15 kHz) ±0.8 dB [For the United Kingdom]	
CD, TAPE/MD, DVD, TV, VCR 1, VCR 2, VCR 3	10 Hz–70 kHz, ±3 dB
[For Australia and New Zealand]	
CD, TAPE, DVD, TV, VCR 1, VCR 2, VCR 3	10 Hz–70 kHz, ±3 dB
Input sensitivity and impedance	
PHONO	3 mV/47 kΩ
[For the United Kingdom]	
CD, TAPE/MD, DVD, TV, VCR 1, VCR 2, VCR 3	200 mV/22 kΩ
[For Australia and New Zealand]	
CD, TAPE, DVD, TV, VCR 1, VCR 2, VCR 3	200 mV/22 kΩ
S/N at rated power (6 Ω) (VGCA ON)	
PHONO	70 dB (IHF, A: 80 dB)
[For the United Kingdom]	
CD, TAPE/MD, DVD (L/R/C/LS/RS), TV, VCR 1, VCR 2, VCR 3	113 dB (IHF A, rated power, S=2 V), 98 dB (IHF, A: 100 dB)
[For Australia and New Zealand]	
CD, TAPE, DVD (L/R/C/LS/RS), TV, VCR 1, VCR 2, VCR 3	113 dB (IHF A, rated power, S=2 V), 98 dB (IHF, A: 100 dB)
Tone controls	
BASS	50 Hz, +10 to –10 dB
TREBLE	20 kHz, +10 to –10 dB
Output voltage	
[For the United Kingdom]	
TAPE/MD REC (OUT), VCR 1 OUT	200 mV
[For Australia and New Zealand]	
TAPE REC (OUT), VCR 1 OUT	200 mV
Channel balance (250 Hz– 6.3 kHz)	±1 dB
Channel separation	55 dB
Headphones output level and impedance	430 mV/330 Ω
Subwoofer frequency response (–6 dB)	7–200 Hz

Digital input (OPTICAL)	CD, DVD, TV
-------------------------	-------------

■ FM TUNER SECTION

Frequency range	87.50–108.00 MHz
Sensitivity	
S/N 30 dB	1.5 μV/75 Ω
S/N 26 dB	1.3 μV/75 Ω
S/N 20 dB	1.2 μV/75 Ω
IHF usable sensitivity (IHF'58)	1.5 μV/75 Ω
IHF 46 dB stereo quieting sensitivity	22 μV/75 Ω
Total harmonic distortion	
MONO	0.2 %
STEREO	0.3 %
S/N	
MONO	60 dB (75 dB, IHF)
STEREO	58 dB (71 dB, IHF)
Frequency response	
20 Hz–15 kHz	+1 dB, –2 dB
Alternate channel selectivity	
±400 kHz	65 dB
Capture ratio	1.5 dB
Image rejection at 98 MHz	40 dB
IF rejection at 98 MHz	70 dB
Spurious response rejection at 98 MHz	70 dB
AM suppression	50 dB
Stereo separation	
1 kHz	40 dB
Carrier leak	
19 kHz	–30 dB (–35 dB, IHF)
38 kHz	–50 dB (–55 dB, IHF)
Channel balance (250 Hz–6.3 kHz)	±1.5 dB
Limiting point	1.2 μV
Bandwidth	
IF amplifier	180 kHz
FM demodulator	1000 kHz
Antenna terminal	75 Ω (unbalanced)

■ AM TUNER SECTION

Frequency range	522–1611 kHz (9 kHz steps) 530–1620 kHz (10 kHz steps)
Sensitivity	20 μV, 330 μV/m
Selectivity (at 999 kHz)	55 dB
IF rejection (at 999 kHz)	50 dB

■ VIDEO SECTION

Output voltage at 1 V input (unbalanced)	1±0.1 V _{p-p}
Maximum input voltage	1.5 V _{p-p}
Input/output impedance	75 Ω (unbalanced)

■ GENERAL

Power supply	AC 230–240 V, 50 Hz
Power consumption	270 W
Dimensions (W x H x D)	[SA-DA10] 430 x 180 x 370 mm [SA-DA8] 430 x 158 x 370 mm
Mass	[SA-DA10] 12.7 kg [SA-DA8] 11.7 kg

Power consumption in standby mode:	2 W
---	-----

Notes:

- Specifications are subject to change without notice. Mass and dimensions are approximate.
- Total harmonic distortion is measured by the digital spectrum analyzer.